



NATURAL RESOURCES INVENTORY

24-020

February 26, 2024

Prepared for:
DuPage County

Petitioner:
Afsar Developers, LLC
17W733 Butterfield Rd. Ste. F
Oakbrook Terrace, IL 60181

PURPOSE AND INTENT

This Natural Resources Inventory is intended to present the most current natural resource information available for a parcel, lot, or tract of land in an understandable format. It contains a description of the present conditions and resources available and their potential impact on each other, especially in regards to a proposed change to that parcel of land. This information comes from standardized data, investigations of the parcel, and other information furnished by the petitioner. **This report must be read in its entirety**, so that the relationship between natural resource factors and the proposed land use can be fully understood.

This report presents natural resource information to owners, land-managers, officials of local governing bodies, and other decision makers concerning the parcel. Decisions concerning variations, amendments, or relief of local zoning ordinances may reference this report. Also, decisions concerning the future of a proposed subdivision of vacant or agricultural lands, and the subsequent development of these lands may reference this report. This report is a requirement under the State of Illinois Soil and Water Conservation District Act contained in ILCS 70, 405/1 ET seq.

This report provides the best available natural resource information for the parcel and when used properly, will provide the basis for good land use change decisions and proper development while protecting the natural resource base of the county. However, because of the variability of nature, and because of the limitations of map scale and the precision of natural resource maps (which includes

the property boundaries represented for the parcel), this report does not reflect precise natural resource information at specific locations within the parcel. On-site investigations, soil evaluations, and engineering studies should be conducted as necessary, for point-specific information.

This Natural Resources Inventory report is a review of the major natural resources of the site and a general estimate of the suitability of this site for the proposed use. Because of the small size of this parcel and because of the inherent probable errors in the precision of natural resource information at the scale of natural resource maps, the KDSWCD makes no opinion on the suitability of this site for the proposed use but may give general statements and an estimate of the possible effects of the land use change to the natural resources of this parcel. The information given in this report is based on the review of natural resource maps and literature by the Kane-DuPage Soil and Water Conservation District. The statements in this report are not meant as a recommendation for the success, nor the failure of, the proposed use of this parcel.

This report should alert the reader to the capabilities of the parcel and to the possible issues that may occur if the properties and characteristics of the land are ignored. Please direct technical questions about information supplied in this report to:

**Kane-DuPage Soil & Water Conservation District
2315 Dean Street, Suite 100
St. Charles, IL 60175
Phone: (630) 584-7960 x3**

TABLE OF CONTENTS

PARCEL LOCATION4

LAND COVER IN THE EARLY 1800'S5

NATIONAL WETLAND INVENTORY (NWI)6

DUPAGE COUNTY WETLANDS.....7

FLOODPLAINS8

WATERSHEDS AND STREAMS9

WATERSHEDS AND SUBWATERSHEDS.....10

AQUIFER SENSITIVITY.....11

TOPOGRAPHY AND OVERLAND FLOW.....12

STORMWATER MANAGEMENT13

SOIL EROSION13

HIGHLY ERODIBLE LAND (HEL)14

SOILS & SOIL INTERPRETATIONS15

SOIL SURVEY16

SOIL MAP UNIT DESCRIPTIONS17

SOIL INTERPRETATIONS – DWELLINGS WITH BASEMENTS15

SOIL INTERPRATIONS – SHALLOW EXCAVATIONS16

SOIL INTERPRETATIONS – LOCAL ROADS AND STREETS17

WATER TABLE21

HYDRIC SOILS.....22

REGULATORY INFORMATION23

REGULATORY AGENCIES23

CONTACTS24

REFERENCES25

EXECUTIVE SUMMARY26

SITE INSPECTION28

SITE INSPECTION PHOTOS29

TABLE OF FIGURES

FIGURE 1: PLAT MAP WITH AERIAL BACKGROUND AND PARCEL BOUNDARY4

FIGURE 2: LAND COVER OF ILLINOIS IN THE EARLY 1800’S5

FIGURE 3: NATIONAL WETLAND INVENTORY (NWI) MAP.....6

FIGURE 4: DUPAGE COUNTY WETLAND MAP.....7

FIGURE 5: FLOODPLAIN MAP - FEDERAL EMERGENCY MANAGEMENT AGENCY (FEMA)8

FIGURE 6: WATERSHEDS AND SUBWATERSHEDS MAP..... 10

FIGURE 7: AQUIFER SENSITIVITY TO CONTAMINATION MAP 11

FIGURE 8: TOPOGRAPHIC MAP SHOWING CONTOUR LINES 12

FIGURE 9: HIGHLY ERODIBLE LAND MAP 14

FIGURE 10: SOIL SURVEY 16

FIGURE 11: SOIL INTERPRETATIONS FOR DWELLINGS WITH BASEMENTS 18

FIGURE 12: SOIL INTERPRETATIONS FOR SHALLOW EXCAVATIONS 19

FIGURE 13: SOIL INTERPRETATIONS FOR LOCAL ROADS AND STREETS 20

FIGURE 14: MAP SHOWING THE DEPTH TO A SEASONAL HIGH-WATER TABLE 21

FIGURE 15: HYDRIC SOILS MAP 22

FIGURE 16: LOCATION OF SITE INSPECTION PHOTOS 28

PARCEL LOCATION

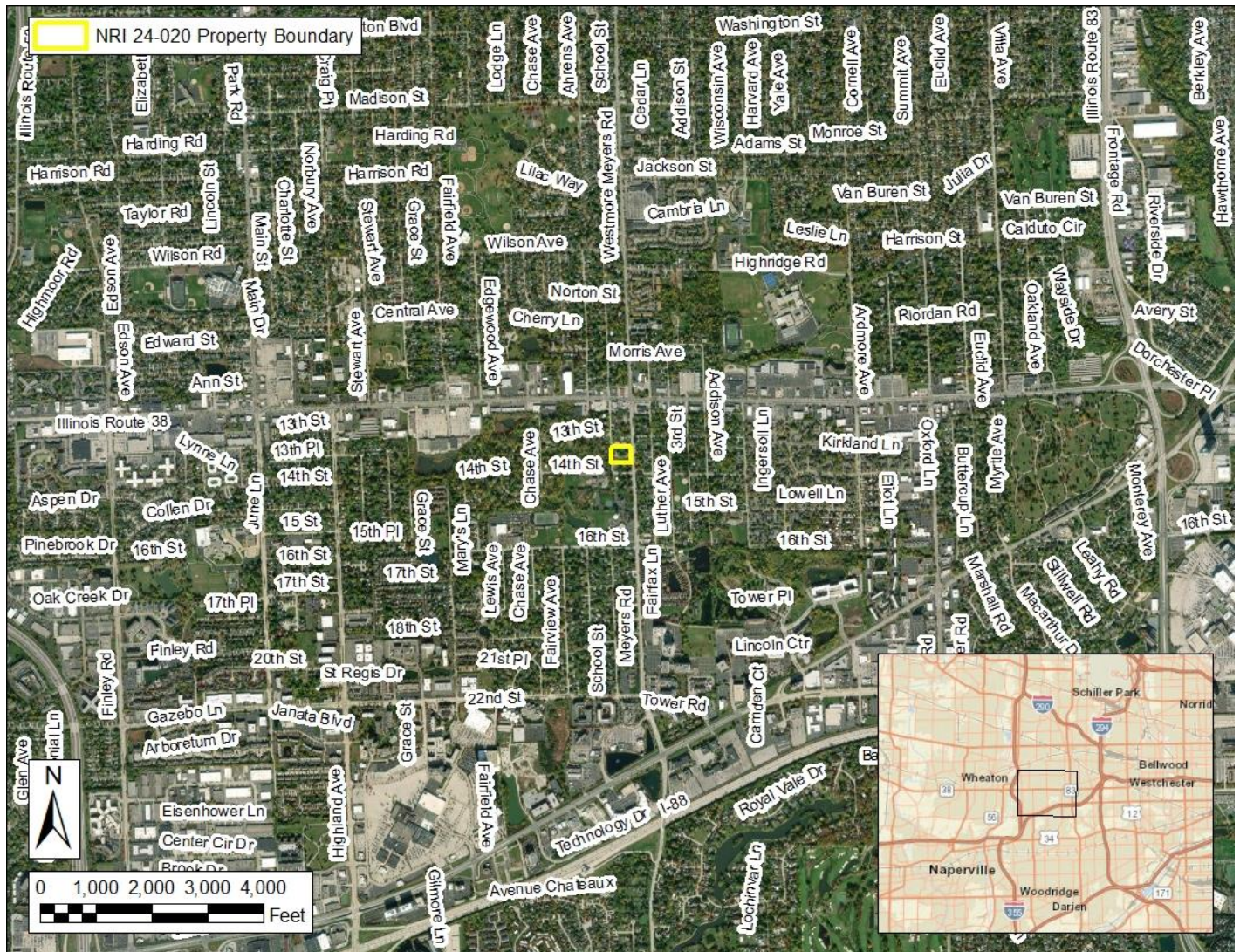

Figure 1: Plat Map with aerial background and parcel boundary

This site is in York Township. The public land survey system identifies the site in **Section 21 in Township 39 North and Range 11 East**. The site is parcel #06-21-102-011, 06-21-102-012, 06-21-102-013 located at 1312 S. Meyers Rd. in Lombard, IL.

LAND COVER IN THE EARLY 1800'S

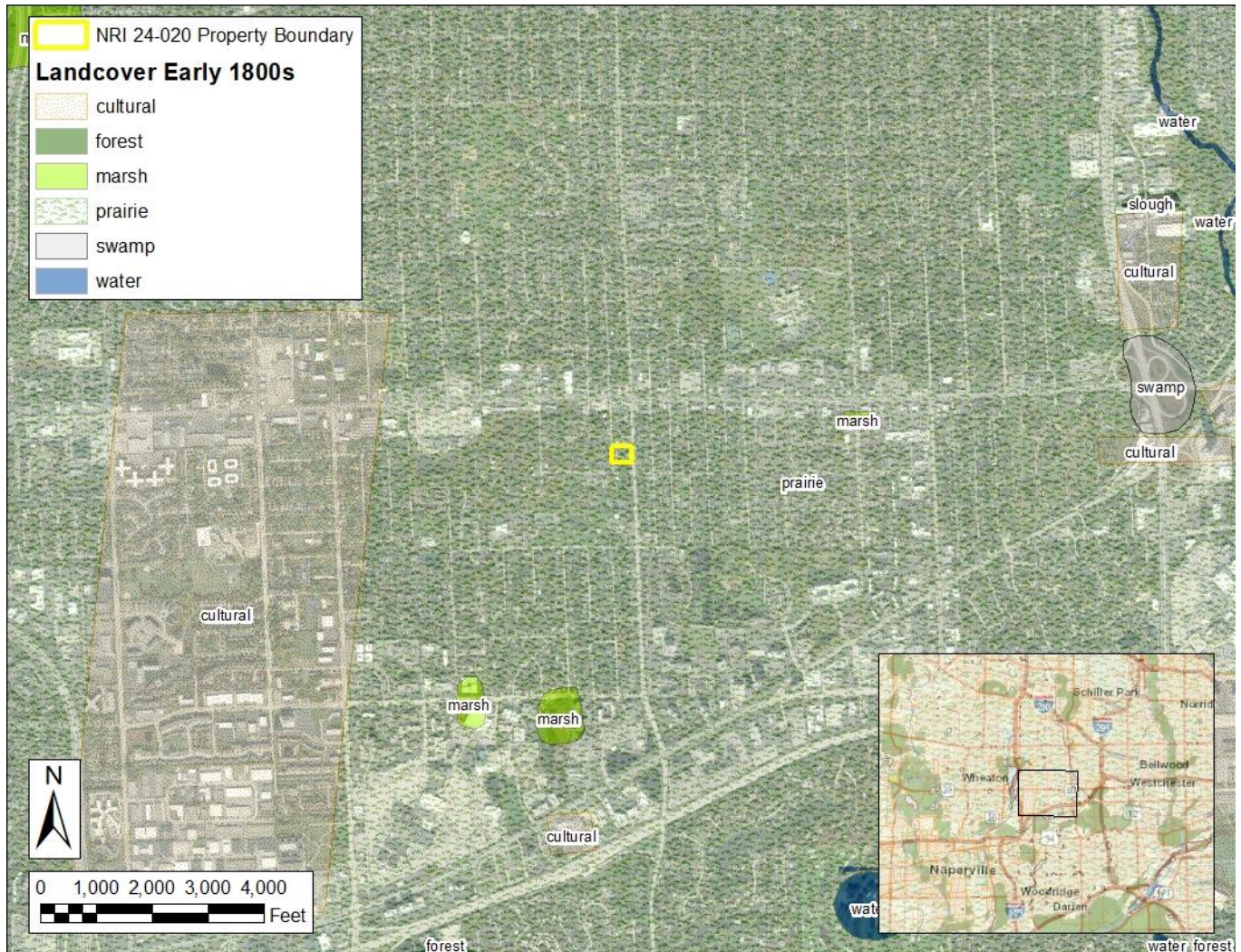

Figure 2: Land Cover of Illinois in the Early 1800's

The public land survey system represents one of the earliest detailed maps for Illinois. The surveys began in 1804 and were largely completed by 1843. The surveyors recorded the land cover and natural resource areas as they worked across the state. These plat maps and field notebooks contain a wealth of information about what the landscape was like before large numbers of settlers came into the state and began modifying the land.

Much of the landscape of Illinois in the early 1800's consisted of two different natural resource areas; prairie and forest. The forest category includes woodlands and savannas, typical of northeastern Illinois. Prairie and forest ecosystems are extremely valuable resources for many reasons. These areas:

- provide wildlife habitat and support biodiversity
- provide areas for recreational opportunities

- improve soil health and reduce soil loss
- improve air and water quality

The original 42 categories of natural resource areas were later simplified to 12 categories; barrens, bottomland, cultural (farms), forest, marsh, other wetlands, prairie, slough, swamp, special geographic features, wet prairie, and water. The maps do not represent exact site conditions, but represent the observations of individual surveyors as they crossed through the area.

This site is recorded as prairie land cover on the early 1800's map. The Kane-DuPage Soil & Water Conservation District recommends preserving as much of the natural character of the site as possible, using native plants for landscaping, and removing and controlling invasive species.

NATIONAL WETLAND INVENTORY (NWI)

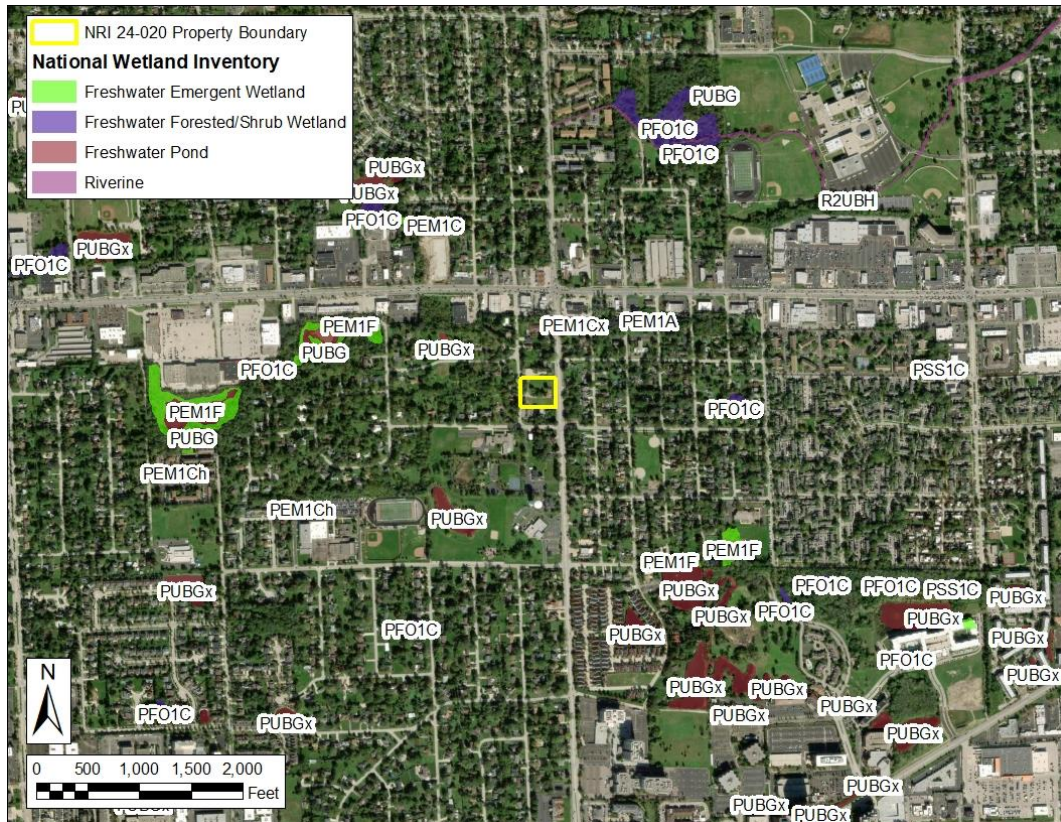

Figure 3: National Wetland Inventory (NWI) Map

The National Wetland Inventory (NWI), conducted by the U.S. Fish and Wildlife Service, identifies significant wetlands throughout the country. All U.S. federal agencies define wetlands as follows, “Those areas that are inundated or saturated by surface or ground water at a frequency and duration sufficient to support, and that under normal circumstances do support, a prevalence of vegetation typically adapted for life in saturated soil conditions. Wetlands generally include swamps, marshes, bogs and similar areas.” Other common wetlands located in this part of Illinois are fens, wet meadows, seasonally saturated soils, and farmed wetlands.

Wetlands are protected and regulated by federal, state, and local laws, without regard to size. Wetlands are valuable, productive, and diverse ecological systems and provide multiple benefits, including:

- controlling flooding by slowing the release of excess water downstream or through the soil,

- cleansing water by filtering out sediment and pollutants,
- functioning as recharge areas for groundwater,
- providing essential breeding, rearing, and feeding habitat for many species of wildlife.

A review of the National Wetland Inventory indicates that there are **no NWI wetlands** on this site. Although the NWI is very thorough, it is not a complete inventory of all possible wetlands. Other regulated wetlands may be present.

The KDSWCD recommends contacting the U.S. Army Corps of Engineers and the DuPage County Stormwater Management Department before commencing any construction activities that may impact wet areas or floodplains. Please see the information on Regulatory Agencies (page 23) for wetland regulation information.

DUPAGE COUNTY WETLANDS

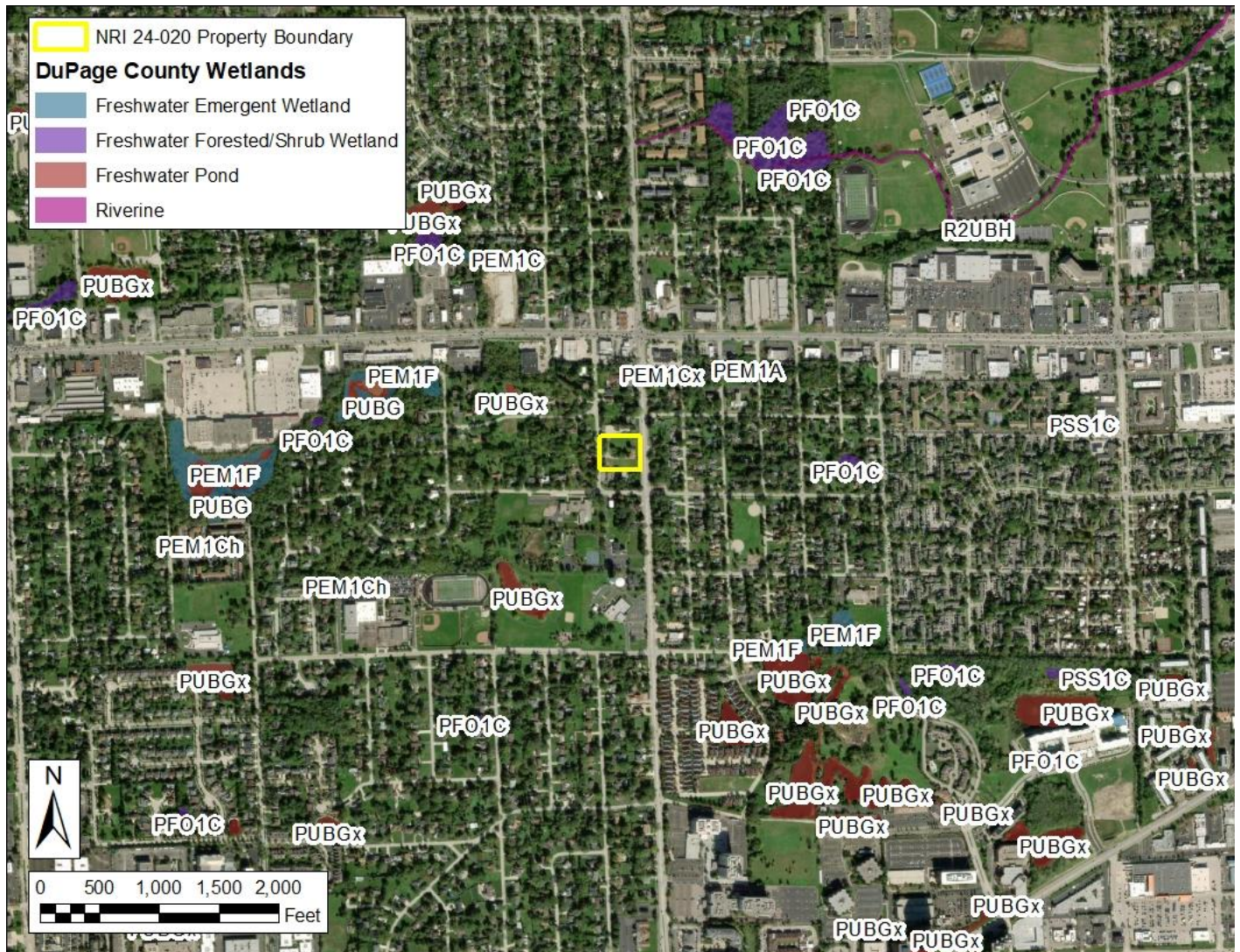

Figure 4: DuPage County Wetland Map

Completed in 2014 and updated periodically, the DuPage County Wetland Initiative was a cooperative effort between DuPage County and the U.S. Environmental Protection Agency to identify the location and quality of the wetlands of DuPage County and to develop wetland protection strategies. This initiative was developed to provide improved awareness of the locations, functions, and values of wetlands and other waters of the United States. The information can be used by federal, state, and local government to aid in zoning, permitting, and land acquisition decisions. In addition, the information can provide data to agencies, landowners, and private citizens interested in restoration or protection of aquatic sites and resources.

For more detailed information regarding wetlands in DuPage County, please refer to the information at: https://www.dupagecounty.gov/government/departments/stormwater_management/stormwater_permitting/special_management_areas/

A review of the DuPage County Wetlands Map revealed that no wetlands were identified on this site.

FLOODPLAINS

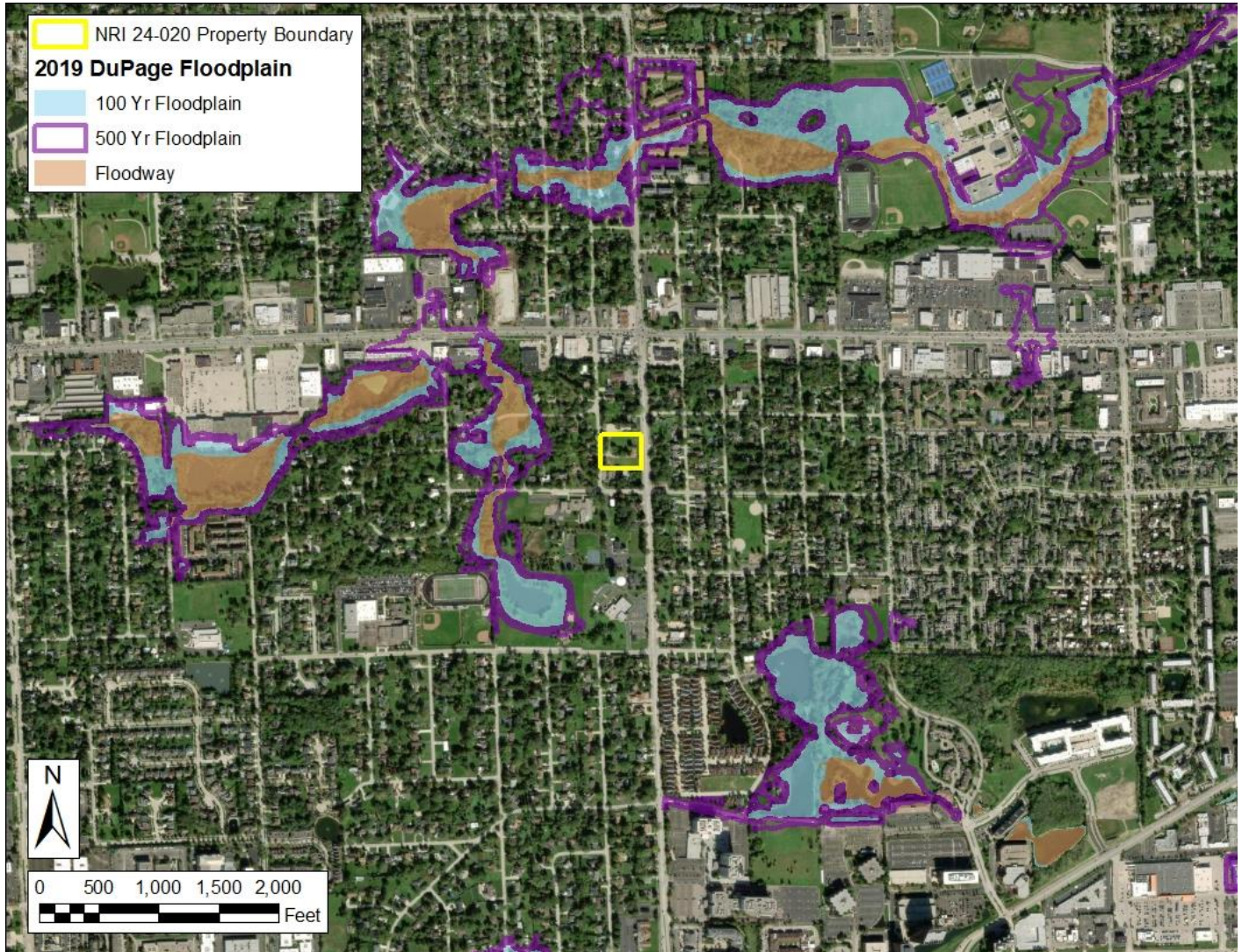

Figure 5: Floodplain map - Federal Emergency Management Agency (FEMA)

Undeveloped floodplains provide many natural resources and functions of considerable economic, social, and environmental value. Floodplains often contain wetlands and other important ecological areas as part of a total functioning system that impacts directly on the quality of the local environment.

Here are a few of the benefits and functions of floodplains:

- natural flood storage and erosion control
- water quality maintenance
- groundwater recharge
- nutrient filtration
- biological productivity/wildlife habitat

- recreational opportunities/aesthetic value
- Also, development in a floodplain has a hazardous risk of damage by high flood waters and stream overflow. For this reason, floodplains are generally unsuited to most development and structures.

According to the FEMA Flood Insurance Rate Map, **none** of this site is within the boundaries of a 100-year floodplain. Any development in the floodplain, other than restoration efforts, is generally unsuited and hazardous and will impede the beneficial functions of the floodplain.

Please see the information on Regulatory Agencies (page 23) for information regarding floodplain regulations.

WATERSHEDS AND STREAMS

Watersheds are areas of land that eventually drain into a river or stream. Everyone lives in a watershed, no matter if a river or stream is nearby. Watersheds may be named according to its major river or stream. Watersheds, such as the Mississippi River watershed, may be extremely large, encompassing multiple states. Watersheds may also be subdivided into smaller units, such as subwatersheds. Some very small watersheds may not contain a named stream. However, the water that drains from that watershed eventually reaches a stream or river.

Watersheds in the United States are delineated by the U.S. Geological Survey (USGS) using a nationwide system based on surface hydrologic features.

Examples of these surface hydrologic features include discharge flow, substratum size, stream width, and depth. This USGS system divides the country into 22 regions (2-digit), 245 subregions (4-digit), 405 basins (6-digit), nearly 2,400 subbasins (8-digit), roughly 19,000 watersheds (10-digit), and approximately 105,000 subwatersheds (12-digit). The USGS uses this system to assign each hydrologic area with a hierarchical Hydrologic Unit code (HUC), which consists of 2 additional digits for each level within the hydrologic unit system.

A complete list of Hydrologic Unit codes, descriptions, names, and drainage areas can be found in the [United States Geological Survey Water-Supply Paper 2294](#), entitled "Hydrologic Unit Maps".

Common Watershed Goals:

- Protect and restore natural resources
- Improve water quality
- Reduce flood damage
- Enhance and restore stream health
- Guide new developments to benefit watershed goals
- Preserve and develop green infrastructure
- Enhance education and stewardship

In DuPage County, many watershed plans have already been developed. Please follow the link below to the DuPage County Stormwater Management Watershed Plans.

https://www.dupagecounty.gov/government/departments/stormwater_management/floodplain_mapping/watershed_planning_and_modeling.php

Rivers and Streams are necessary components of successfully functioning ecosystems. It is important to protect the beneficial functions and integrity of our local streams and rivers. Development near stream systems has the potential to increase flooding, especially in urban areas where there is a lot of impervious surfaces and a greater amount of stormwater runoff. Pollution is also an issue for stream systems in urban and rural areas. It is rare for any surface waters to be impacted by only one source of pollution. With few exceptions, every land-use activity is a potential source of nonpoint source water pollution.

The Illinois Environmental Protection Agency (IEPA) provides the following in regard to nonpoint source pollution, "Nonpoint source pollution (NPS) occurs when runoff from rain and snowmelt carries pollutants into waterways such as rivers, streams, lakes, wetlands, and even groundwater. Examples of or sources of NPS pollution in Illinois include runoff from farm fields, livestock facilities, construction sites, lawns and gardens, city streets and parking lots, surface coal mines, and forestry. The major sources of NPS pollution in Illinois are agriculture, urban runoff, and habitat modification."

Nutrient management is of vital importance to the health of our rivers and streams. Nutrient load in our local streams and rivers has contributed to the Gulf of Mexico hypoxia, or a "dead zone" located where the Mississippi River meets the Gulf of Mexico. This dead zone has little to no biological activity. Yearly averages indicate the dead zone to be greater than 5,000 square miles in size. Illinois was required and has introduced a plan to reduce nutrient loss from point source pollution sources, such as wastewater treatment plants and industrial wastewater, as well as nonpoint pollution sources.

Read Illinois's Plan for reducing nutrient loss here:

<https://epa.illinois.gov/topics/water-quality/watershed-management/excess-nutrients/nutrient-loss-reduction-strategy.html>

WATERSHEDS AND SUBWATERSHEDS

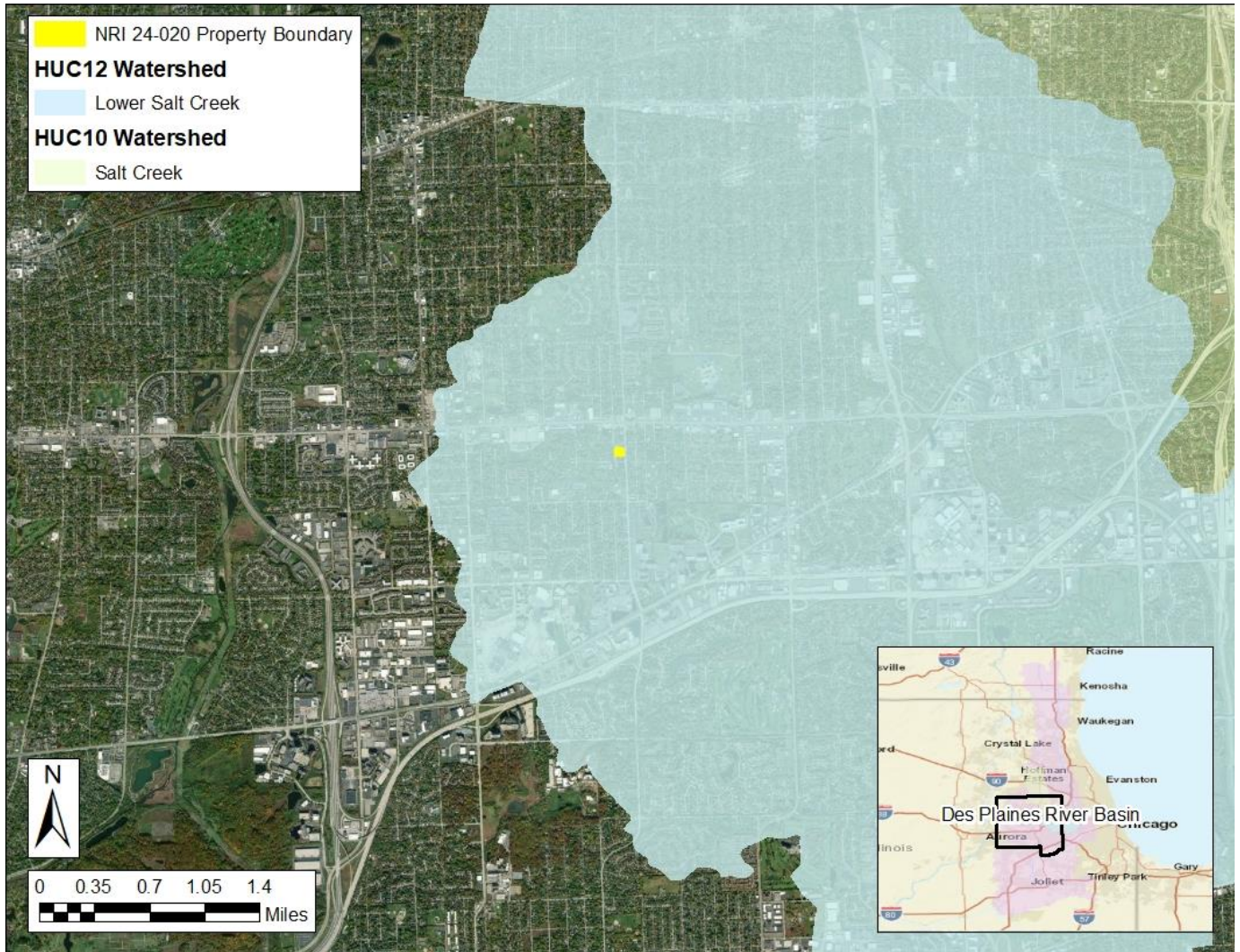

Figure 6: Watersheds and Subwatersheds

DuPage County has been divided into two major watershed subbasins by federal and state agencies, based upon the drainage area of local rivers: the Des Plaines River Subbasin, that covers a majority of DuPage County, and the Lower Fox River Subbasin, that occupies the western portion of the county. These subbasins are part of the Illinois River watershed and part of the greater Mississippi River watershed. Within DuPage County, the Des Plaines River Subbasin is divided into the Willow Creek-Des Plaines River Watershed; the Salt Creek Watershed; the DuPage River Watershed; and the Chicago Sanitary and Ship Canal-Des Watershed. The portion of the Lower Fox River Subbasin in DuPage County is further divided into the Ferson Creek-Fox River Watershed. These watersheds are then divided further into smaller local subwatersheds for planning.

Local watershed management planning is an important effort for the protection of local water resources and can involve watershed organizations, citizens, communities, municipalities, as well as state, local, tribal and/or federal environmental agencies. Water quality is a direct reflection of its watershed.

The map above indicates that 100 percent of this site is located within the boundaries of subwatershed HUC12-071200040404 Lower Salt Creek of the HUC10-0712000404 Salt Creek watershed.

AQUIFER SENSITIVITY



Figure 7: Aquifer sensitivity to contamination map

The U.S. Environmental Protection Agency defines aquifer sensitivity/contamination potential as “a measure of the ease with which a contaminant applied on or near the land surface can migrate to an aquifer.” Aquifers function as a storage area for groundwater recharge, which makes them a reliable source of fresh water. Groundwater from aquifers is a valuable source of drinking water when it remains uncontaminated.

According to the Illinois State Geological Survey, this site lies completely or partially within a zone rated as **very limited** with respect to potential for contamination from spilled or applied substances to the soil surface.

Contact the KDSWCD for references regarding application of chemicals and best management practices to reduce the risk of aquifer contamination from this site.

TOPOGRAPHY AND OVERLAND FLOW

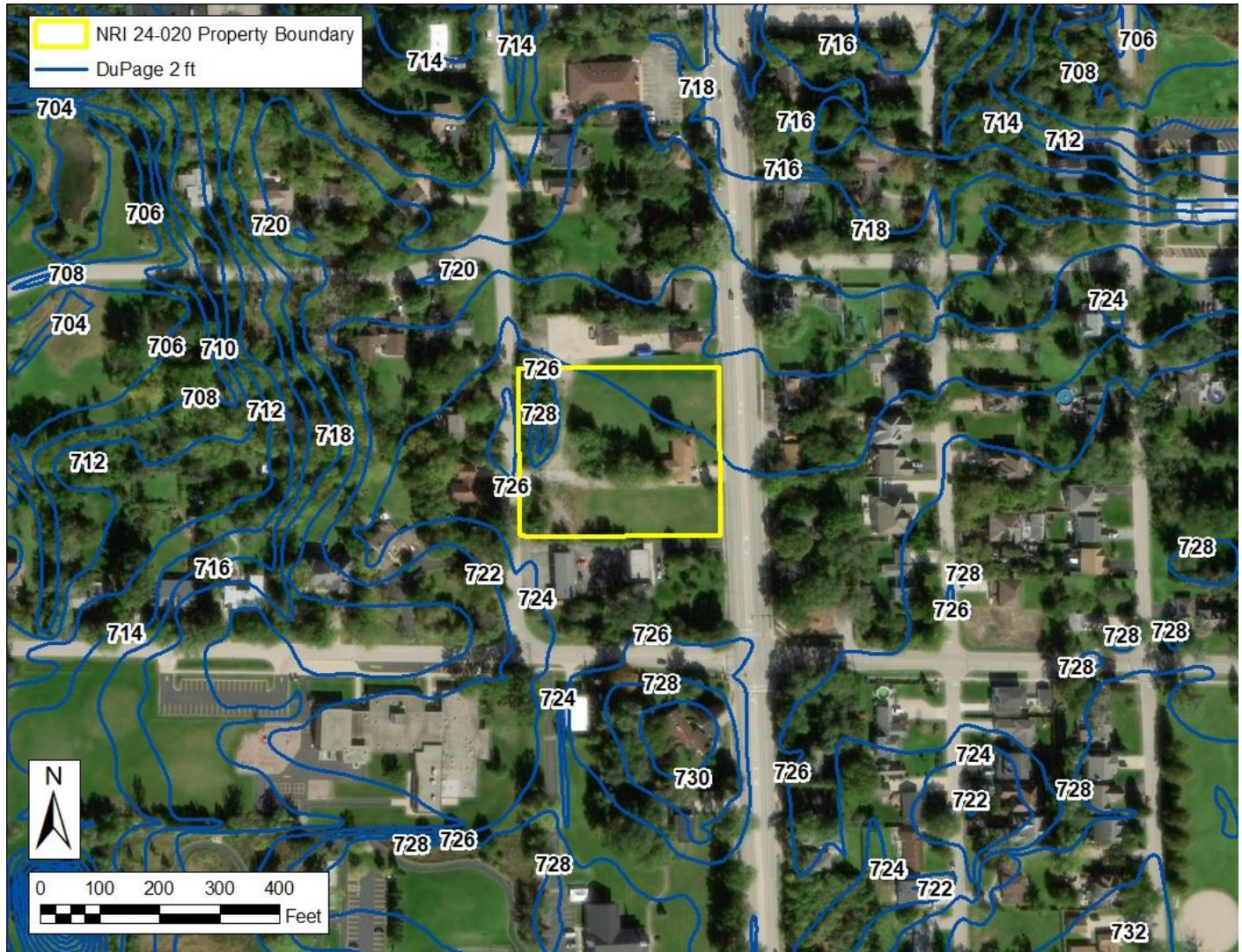

Figure 8: Topographic map showing contour lines

Topographic maps (contour maps) give information on the elevation of the land, which is important to determine slope steepness, natural water flow paths, and watershed information. The natural water flow path can determine where water leaves a property and where it may impact surrounding natural resources. Slope, along with soil erodibility factors, affect the potential of soil erosion on a site. Contour maps can also help determine the areas of potential flooding. It is important to consider the direction of water flow and erosion potential on all construction sites. Areas where water leaves the site should be monitored for sediment and other pollutants, which

could contaminate downstream waters.

The map above shows contour lines with 2 feet elevation distance between each line. The high point of this property is in the western portion of the site at an elevation of approximately 728 feet above sea level. The property generally drains to the northeast via overland flow. The lowest elevation on the property is approximately 724 feet above sea level.

Please Note: This site’s actual topography does not match the map. The site has been materially altered after the topological map information was gathered and produced.

STORMWATER MANAGEMENT

Managing stormwater and stormwater runoff is critical for all development. Stormwater runoff from a site usually increases as a result of soil compaction, more impervious surfaces, loss of vegetation, and soil degradation during construction activities. Increased runoff causes downstream flooding, soil erosion, sedimentation, and pollution of surface waters. The KDSWCD recommends the use of onsite stormwater management strategies whenever possible. These strategies include: stormwater retention and detention basins; bioswales, raingardens, and the use of natural depressions and vegetated swales; deep-rooted native plants; permeable pavers or permeable asphalt. Combinations of these and other practices may be able to retain stormwater onsite. The Illinois Environmental Protection Agency (IEPA) now

recommends that stormwater pollution prevention plans include post-construction stormwater management to keep as much stormwater on the site, as possible.

Site assessment with soil testing should help to determine what stormwater management practices are best for your site. Insufficient stormwater management has the potential to cause or aggravate flooding conditions on surrounding properties, or elsewhere in the watershed. Please refer to the DuPage County Stormwater Ordinance for stormwater requirements and minimum standards.

https://www.dupagecounty.gov/government/departments/stormwater_management/stormwater_permitting/stormwater_ordinance/

SOIL EROSION

Soil erosion is the degradation of soil, mostly caused by the force of rain and the movement of water detaching soil particles and carrying the soil off the site. Factors that affect soil erosion are the slope of the land, the inherent properties of the soil, and the cover (or lack of cover) on the soil surface. Extra care must be taken to prevent or reduce soil erosion on construction sites containing highly erodible soils.

The potential for soil erosion during and after construction activities could have major impacts, both onsite and offsite. The erosion and resulting sedimentation may become a primary nonpoint source of water pollution. Eroded soil during the construction phase can create unsafe conditions on roadways, degrade water quality, and destroy aquatic ecosystems lower in the watershed. Soil erosion also increases the risk of flooding due to choking culverts, ditches, and storm sewers, and reduces the capacity of natural and man-made detention facilities.

Construction and development activities should include a soil erosion and sedimentation control plan. Erosion and sedimentation control measures include:

- Staging construction to minimize the number of disturbed areas present at the same time
- Keeping the ground covered, either by mulch or vegetation
- Keeping runoff rates minimal

Many construction sites are required to develop and follow a Stormwater Pollution Prevention Plan (SWPPP) in order to be in compliance with local, state, and federal laws regarding soil erosion and stormwater management. Soil erosion and sedimentation control plans, including maintenance responsibilities, should be clearly communicated to all contractors working on the site. Special care must be taken to protect any wetlands, streams, and other sensitive areas.

Please refer to the Illinois Urban Manual for erosion and sediment control information and technical guidance when creating erosion and sediment control plans. The practice standards and standard drawings from the Illinois Urban Manual represent the minimum standard in Illinois. Contact the DuPage County Stormwater Management Department for specific information on permits. Contact the KDSWCD for assistance in preparing a stormwater pollution prevention plan.

HIGHLY ERODIBLE LAND (HEL)



Figure 9: Highly Erodible Land map

Soils vary in their susceptibility to erosion. Highly erodible land (HEL) is land that can erode at excessive rates. Highly erodible land is generally sloping and contains soils that are susceptible to soil erosion by runoff and raindrop impact. The susceptibility to erosion and the highly erodible rating depends upon several factors and properties of the soil. Fine-textured soils high in clay have low erodibility values, because the soil particles are resistant to detachment. Coarse-textured soils, such as sandy soils also have low erodibility values because the water infiltrates and they have less runoff. Medium textured soils, such as loams, are moderately susceptible to detachment and they produce moderate runoff. Soils having a high silt content, like many soils in DuPage County, are the most erodible of all soils. They are easily detached

and they tend to crust and produce large amounts and rates of runoff.

Other factors that affect the erodibility of soils include the force of the rainfall, the steepness and length of the slope of the land, and the amount of organic matter in the surface soil layer.

Highly Erodible Land (HEL) contains soils that have been determined by the USDA Natural Resources Conservation Service (NRCS) to be highly erodible. The HEL determination uses a formula involving the properties previously described, to determine the Soil Erodibility Index. Soils that have a Soil Erodibility Index above a certain value are considered highly erodible or potentially highly erodible. **Soils on this site are considered Potentially Highly Erodible Land (PHEL) by the NRCS.**

SOILS & SOIL INTERPRETATIONS

Soils are the foundation of life. Soil is a dynamic ecosystem comprised of living things: plants, animals, and microscopic organisms. Soil is also a substance composed of various minerals and organic matter, interfused with lots of pore spaces which help move and store air and water. Soils are formed over hundreds and thousands of years, taking about 500 years to form an inch of topsoil. Soil is formed by the influences of climate, organisms (plants and animals), topography, the material in which it is developing (parent material), and time. There are thousands of soil series in the world. In Illinois alone, there are over 600 different soil series. Each soil series is unique in its content and its behavior for a particular use.

The different soils across the U.S. have been mapped and identified by the USDA Natural Resources Conservation Service (NRCS) in a soil survey. The soil map of this area (Figure 10: Soil Survey) indicates different soil map units. Each soil map unit and corresponding symbol represent a phase of a soil series. Phases include slope, erosion, flooding frequency, etc. of each soil. Each soil and associated phase have strengths and limitations for a variety of land uses such as septic systems, buildings site development, local roads, and many other uses.

See the Soil Map Units Table in the Soil Survey section for the composition of soil map units of the site. See the Soil Interpretations section for the soil interpretations for the proposed use of the site.

How soil is managed as a resource can be either beneficial or detrimental for the environment, or for any other particular use. It is difficult to change the inherent properties of soil, such as the mineral composition or the amount of sand, silt, or clay within soil. However, it is easy to compact or erode soil to the extent that many soil functions, such as water storage, infiltration, rooting medium, carbon storage, and soil health could all become compromised or destroyed. Management techniques to protect the integrity and functions of soil include:

- limiting traffic on the site to reduce compaction of the soil surface
- keeping the soil covered as much as possible, with deep rooted grasses or with mulch or other erosion control practices

- disturbing only the areas necessary for the footprint of structures and reducing or eliminating mass grading of sites

Soils and Onsite Waste Disposal

Soils are often used for onsite waste disposal or underground septic systems to dispose of sewage, especially for individual homes that are not connected to a municipal sewage system. No interpretive rating is given in this report for on-site wastewater disposal (septic systems). The detail of the soil information in the soil survey is not precise enough to determine suitability for the small area required for a septic system.

A Certified Professional Soil Classifier, in cooperation with the county department of public health, must conduct a soil evaluation to determine the suitability of the parcel for on-site wastewater disposal (i.e., septic system), as required by the State of Illinois.

Soil Interpretation Ratings

The soil interpretation (limitation) ratings are used mainly for engineering designs for proposed uses, such as dwellings with or without basements, local streets and roads, small commercial buildings, etc. The ratings given are based on NRCS national criteria and are defined and used as follows:

Not Limited – This limitation rating indicates that the soil properties are generally favorable for the specified use and that any limitations are minor and easily overcome.

Somewhat Limited - This rating indicates that the soil properties and site features are unfavorable for the specified use, but that the limitations are moderate and can be overcome or minimized with special planning and design.

Very Limited - This indicates that one or more soil properties have severe limitations and are very unfavorable and difficult to overcome. A major increase in construction effort, special designs, or intensive maintenance is required. These costly measures may not be feasible for some soils that are rated as Very Limited.

Contact the KDSWCD for questions concerning soil and refer to the **Illinois Urban Manual** for best management practices for protecting soil.

SOIL SURVEY



Figure 10: Soil Survey

The soil map unit symbol consists of a combination of numbers and letters which represent the interpretive phase of a soil series for an area of the landscape. Areas within the line of that symbol will have similar soil properties and interpretations.

Table 1: Soil Map Units

SOIL MAP UNIT SYMBOL	PERCENT OF PARCEL	ACRES
531B – Markham	100%	2
	Total	2

All percentages and acreages are approximate.

The soil map in this report has been enlarged beyond the original scale. Enlargement of this map may cause misunderstanding of the accuracy and

precision of the mapping. When enlarged, maps do not show the small areas of contrasting soil that could have been identified if the mapping was completed at a larger scale. The depicted soil boundaries and interpretations derived from the map units do not eliminate the need of onsite sampling, testing, and detailed study of specific sites for intensive uses. Thus, this map and its interpretations are intended for planning purposes only.

The KDSWCD suggests to contact a certified professional soil classifier to conduct an onsite investigation for point-specific soil information to determine the capabilities and the limitations of the soil for a specific use.

SOIL MAP UNIT DESCRIPTIONS

The map units delineated on the detailed soil map in a soil survey represent the soils or miscellaneous areas in the survey area. The map unit descriptions in the report, along with the map, can be used to determine the composition and properties of a unit.

A map unit delineation of a soil map represents an area dominated by one or more major kinds of soil or miscellaneous area. A map unit is identified and named according to the taxonomic classification of the dominant soils. Within a taxonomic class there are precisely defined limits for the properties of the soils. On the landscape, however, the soils are

natural phenomena, and they have the characteristic variability of all natural phenomena. Thus, the range of some observed properties may extend beyond the limits defined for a taxonomic class. The scale of the maps limits the detail that can be shown. Areas of soils of a single taxonomic class rarely, if ever, can be mapped without including areas of other taxonomic classes. Consequently, every map unit is made up of soils or miscellaneous areas for which it is named and some minor components that belong to taxonomic classes other than those of the major soils. These minor components are inclusions within the named map unit.

LIST OF MAP UNITS

531B Markham silt loam, 2 to 4 percent slopes

SOIL INTERPRETATIONS – Dwellings with Basements



Figure 11: Soil Interpretations for Dwellings with Basements

Dwellings are single-family houses of three stories or less. For dwellings with basements, the foundation is assumed to consist of spread footings of reinforced concrete built on undisturbed soil at a depth of about 7 feet.

The ratings for dwelling are based on the soil properties that affect the capacity of the soil to support a load without movement and on the properties that affect excavation and construction costs. The properties that affect the load-supporting capacity include depth to water table, ponding, flooding, subsidence, linear extensibility (shrink-swell potential), and compressibility. Compressibility is inferred from the Unified classification of the soil.

These properties include water table, ponding, flooding, slope, depth to rock, and the amount of rock fragments. **The high-water table is often a limiting factor in DuPage County.**

Areas not shaded represent NOT LIMITED, and good performance and very low maintenance can be expected. Yellow represents SOMEWHAT LIMITED, and fair performance and moderate maintenance can be expected. Red represents VERY LIMITED, and poor performance and high maintenance are to be expected.

See the preceding **Soils Section** for more information concerning soil limitations.

SOIL INTERPRETATIONS – Shallow Excavations



Figure 12: Soil Interpretations for Shallow Excavations

Shallow excavations are trenches or holes dug to a maximum depth of 5 or 6 feet for graves, utility lines, open ditches, or other purposes. The ratings are based on the soil properties that influence the ease of digging and the resistance to sloughing. Depth to bedrock, hardness of bedrock, the amount of large stones, and dense layers influence the ease of digging, filling, and compacting. Depth to the seasonal high-water table, flooding, and ponding may restrict the period when excavations can be made. Slope influences the ease of using machinery. Soil texture, depth to the water table, and linear extensibility (shrink-swell potential) influence the

resistance to sloughing. **The high-water table is often a limiting factor in DuPage County.**

Areas not shaded represent NOT LIMITED, and good performance and very low maintenance can be expected. Yellow represents SOMEWHAT LIMITED, and fair performance and moderate maintenance can be expected. Red represents VERY LIMITED, and poor performance and high maintenance are to be expected.

See the preceding Soils Section for more information concerning soil limitations.

SOIL INTERPRETATIONS – Local Roads and Streets



Figure 13: Soil Interpretations for Local Roads and Streets

Local roads and streets have an all-weather surface and carry automobile and light truck traffic all year. They have a subgrade of cut or fill soil material; a base of gravel, crushed rock, or soil material stabilized by lime or cement; and a surface of flexible material (asphalt), rigid material (concrete), or gravel with a binder.

The ratings are based on the soil properties that affect the ease of excavation and grading and the traffic-supporting capacity. The properties that affect the ease of excavation and grading are depth to bedrock or a cemented pan, hardness of bedrock or a cemented pan, depth to a water table, ponding, flooding, the amount of large stones, and slope. The properties that affect the traffic-supporting capacity

are soil strength (as inferred from the AASHTO group index number), subsidence, linear extensibility (shrink-swell potential), the potential for frost action, depth to a water table, and ponding. **The high-water table is often a limiting factor in DuPage County.**

Areas not shaded represent NOT LIMITED, and good performance and very low maintenance can be expected. Yellow represents SOMEWHAT LIMITED, and fair performance and moderate maintenance can be expected. Red represents VERY LIMITED, and poor performance and high maintenance are to be expected.

See the preceding **Soils Section** for more information concerning soil limitations.

WATER TABLE



Figure 14: Map showing the depth to a seasonal high-water table

A seasonal high-water table, or the depth to a zone saturated with water in the soil during the wet season (typically spring through early summer), is present in most soils in DuPage County, as it is in much of Illinois. The relatively low relief and flat landscape of the region slows the dissipation of water from the soil. This saturated zone fluctuates throughout the year and is closer to the surface in the spring and drops to deeper levels during summer and fall. Soils that are lower on the landscape are generally wetter than those soils higher on the landscape or on more sloping landscape positions. Some soils, especially those in landscape depressions and low-lying areas, have a water table above the soil surface. Water that occurs above the soil surface is considered “ponded” water. Ponding is different from flooding, as the water in ponded areas comes from water rising from below the soil surface or from runoff from adjacent areas. Flooding comes from the overflow of water from rivers and streams.

The duration of the seasonal high-water table may have been altered by artificial drainage systems,

especially those areas in cropland or former cropland. Even when soils are artificially drained, they will likely retain wet characteristics and the wetness will be difficult to eliminate entirely. However, artificial drainage may shorten the duration of the seasonal high-water table.

The wetness from the seasonal high-water table is a limiting property of the soil for many uses, especially homesites with or without basements, septic absorption fields, commercial buildings, and roads and streets. Most sites that are zoned for construction will require improved drainage, sump pumps, foundation drains, and other management practices to reduce the wetness. Any change to the natural drainage of the site has the potential to create flooding issues downstream from the site, so use caution in installing drainage systems.

The Soil Survey indicates a seasonal high-water table at a depth of 2.49 feet of the soil surface during the spring and early summer in most years, on the wettest soils of the site.

HYDRIC SOILS



Figure 15: Hydric Soils map

Hydric Soils are wet soils that have a water table near the surface or above the surface, mostly in the spring and summer. The wetness is often a result of being on a lower position on the landscape. Many areas of hydric soils have been altered by artificial drainage systems. Even though they may have artificial drainage, they are still considered to meet the definition of a hydric soil. Although not all hydric soils are considered wetlands, hydric soils are a component of wetlands.

Even when hydric soils are artificially drained, they will likely retain wet characteristics and the wetness will be difficult to eliminate entirely. However, artificial drainage may shorten the duration of the seasonal high-water table. Most sites will require improved drainage, sump pumps, and other management practices to reduce the wetness. Any

change to the natural drainage of the site has the potential to create flooding issues on and adjacent to the site, so use caution in installing drainage systems. Some hydric soils are dominated by organic material (peat or muck) instead of mineral soil material and are not suitable construction sites, because of the low strength of the organic deposits. **Organic soils are extremely difficult to modify for other uses.**

Hydric inclusions are small areas (inclusions) of hydric soils in the lower positions of a landscape dominated by higher, nonhydric soils and these inclusions are not identified on the soil map, given the map scale. However, hydric inclusions may still have a significant impact on your site.

According to the Soil Survey, no hydric soils are indicated on this site.

REGULATORY INFORMATION

Wetlands, Rivers, Streams, and Other Waters: The laws of the United States, the State of Illinois, and local governments assign certain agencies specific and different regulatory roles to protect the waters within their jurisdictional boundaries. These roles include protection of navigation channels and harbors, protection against floodway encroachment, maintenance and enhancement of water quality, protection of fish and wildlife habitat, and protection of recreational resources. Unregulated use of waters could permanently destroy or alter the character of these valuable resources and adversely impact the public. Contact the proper regulatory authorities when planning any work associated with floodplains, wetlands, or other waters so that proper consideration and approval can be obtained.

Wetland and/or Floodplain Permit: Anyone proposing to dredge, fill, riprap, or otherwise alter the banks or beds of a floodplain or floodway; or construct, operate, or maintain any dock, pier, wharf, sluice, dam, piling, wall, fence, utility of a lake, stream, or river subject to federal, state, or local regulatory jurisdiction should apply for agency approvals.

Construction Permit: Anyone disturbing an acre or more of land during proposed construction activities should apply for the NPDES General Construction Permit ILR10. Building and stormwater permits should also be obtained locally from municipal government and/or DuPage County.

REGULATORY AGENCIES

Wetlands, Floodplains, Streams, & Other Waters:

U.S. Army Corps of Engineers, Chicago District,
111 North Canal Street
Chicago, IL 60606-7206
(312) 353-6400
<http://www.lrc.usace.army.mil/>

DuPage County Stormwater Management Department

Jack T. Knuepfer Bldg
421 N. County Farm Road
Wheaton, IL 60187
(630) 407-6700
https://www.dupagecounty.gov/government/departments/stormwater_management/

Illinois Department of Natural Resources, Office of Water Resources

2050 W. Stearns Road
Bartlett, IL 60103
(847)608-3100
<https://dnr.illinois.gov/waterresources/programs.html>

NPDES General Construction Permit ILR10

Illinois Environmental Protection Agency, Division of Water Pollution Control
1021 North Grand Avenue East
P.O. Box 19276
Springfield, Illinois 62794
(217)782-0610
<https://www2.illinois.gov/epa/topics/forms/water-forms/Pages/default.aspx>

The KDSWCD recommends early coordination with the regulatory agencies BEFORE finalizing work plans. This allows the agencies to recommend measures to mitigate or compensate for adverse impacts. Also, the agency can make possible environmental enhancement provisions early in the project planning stage. This could reduce time required to process necessary approvals. Please be advised that failure to coordinate with regulatory agencies could result in project shut down, fines and/or imprisonment.

CONTACTS**STATE AGENCIES**

Illinois Department of Natural Resources
1 Natural Resources Way
Springfield, Illinois 62702-1271
(217)782-6302

Illinois Department of Transportation
2300 South Dirksen Parkway
Schaumburg, Illinois 62764-0001
(217)782-7820/(800)452-4368

Illinois Environmental Protection Agency
1021 North Grand Avenue East
P.O. Box 19276
Springfield, Illinois 62794-9276
(217)782-3397

Illinois Natural History Survey
1816 South Oak Street MC652
Champaign, Illinois 61820
(217)333-6880

COUNTY / LOCAL OFFICES

DuPage County Government Center
Jack T. Knuepfer Administration Building
421 N. County Farm Road
Wheaton, IL 60187
630-407-6500

DuPage County Building & Zoning Department
(630) 407-6700

Department of Stormwater Management
(630) 407-6700

Forest Preserve District of DuPage County
3580 Naperville Road
Wheaton, IL 60189
(630) 933-7200

DuPage County Health Department
111 N County Farm Road
Wheaton, IL 60187
Phone: 630-682-7400

Kane-DuPage Soil and Water Conservation District
2315 Dean Street Suite 100
St. Charles, Illinois 60175
(630) 584-7960 ext. 3

FEDERAL AGENCIES

U. S. Army Corps of Engineers
Regulatory Branch
231 S LaSalle Street, Suite 1500
Chicago, Illinois 60604
(312)846-5330
<http://www.usace.army.mil>

U.S. Environmental Protection Agency
Region 5
77 West Jackson Boulevard
Chicago, Illinois 60604
(312)353-2000 or (800)621-8431
<http://www.epa.gov/region5/>

U.S. Fish & Wildlife Service
Chicago Illinois Field Office
230 South Dearborn Suite 2938
Chicago, IL 60604
(847)298-3250
<http://www.fws.gov/>

U.S.D.A. Natural Resources Conservation Service
2315 Dean Street Suite 100
St. Charles, Illinois 60175
(630)584-7960 ext. 3
<http://www.il.nrcs.usda.gov/>

REFERENCES

- Berg, Richard C, Aquifer Sensitivity Classification for Illinois Using Depth to Uppermost Aquifer Material and Aquifer Thickness, Cir. 560, 2001, Illinois State Geological Survey
- Department of Energy and Natural Resources, Illinois State Geological Survey: Potential for Agricultural Chemical Contamination of Aquifers in Illinois: 1995 Revision Environmental Geology 148
- Service Layer Credits Source: Esri, DigitalGlobe, GeoEye, Earthstar Geographics, CNES/Airbus DS, USDA, USGS, AeroGRID, IGN, and the GIS User Community
- Illinois Department of Natural Resources, Ecological Compliance Assessment Tool.
- Illinois Department of Natural Resources, Illinois Natural History Survey, Land Cover of Illinois in the Early 1800s., Vector Digital Data, Version 6.0, August, 2003.
- Illinois Environmental Protection Agency, Nonpoint Source Pollution – What’s It All About, 2015
- Soil Survey Staff, Natural Resources Conservation Service, United States Department of Agriculture. Web Soil Survey. Available online at the following link: <https://websoilsurvey.sc.egov.usda.gov/>. Accessed on the date of this report.
- U.S. Dept. of Homeland Security, Federal Emergency Management Agency, National Flood Insurance Program, Q3 Flood Data, 2011
- U.S. Dept of the Interior, Fish and Wildlife Service, National Wetlands Inventory, Photo Year 1983- 1984, Digitized 1985-1986
- U.S. Geological Survey, Illinois Digital Orthophoto Quadrangles, 2006 photos, Published: Champaign, Illinois State Geological Survey, 2006
- U.S. Geological Survey, Water Supply Paper 2294, Hydrologic Unit Maps. 1994
- <https://pubs.usgs.gov/wsp/wsp2294/>
- Wetlands of DuPage County, Illinois
- <http://gis.dupageco.org/arcgis/rest/services/OpenData>
- 2015 DuPage County, Illinois

EXECUTIVE SUMMARY
APPLICATION 24-020
February 26, 2024

Petitioner: Afsar Developers, LLC, 17W733 Butterfield Rd. Ste. F, Oakbrook Terrace, IL 60181

Contact Person: Mark Daniel, 630-833-3311

Unit of Government Responsible for Permits: DuPage County

Acreage: 2

Area of Disturbance (acreage): 2

Location of Parcel: Section 21, Township 39N, Range 11E

Property Address/PIN#: #06-21-102-011, 06-21-102-012, 06-21-102-013, 1312 S. Meyers Rd. Lombard, IL 60148

Existing Land Use: Vacant/Residential

Proposed Land Use: Residential

NATURAL RESOURCE CONCERNS

Land Cover in the Early 1800’s: This site is in an area previously identified as prairie (page 5).

Wetlands: The National Wetland Inventory map and the DuPage County Wetland Map do not identify wetland areas on this site. If there are any indications of unidentified wetlands on this site, noticed during the proposed land use change, contact the appropriate county and federal wetland regulatory agencies (pages 6-7).

Floodplain: There are no floodplain areas identified on this site (page 8).

Streams: There are no streams on this site (page 9).

Watersheds and Subwatersheds: It is indicated that 100 percent of this site is located within the boundaries of subwatershed HUC12-071200040404 Lower Salt Creek of the HUC10-0712000404 Salt Creek watershed. (page 10).

Aquifer Sensitivity: This site is classified as having a very limited potential for aquifer contamination (page 11).

Topography and Overland Flow: The high point of this property is in the western portion of the site at an elevation of approximately 728 feet above sea level. The property generally drains to the northeast via overland flow. The lowest elevation on the property is approximately 724 feet above sea level (page 12).

Please Note: This site’s actual topography does not match the map. The site has been materially altered after the topological map information was gathered and produced.

Stormwater Management: This site may or may not need a Stormwater Pollution Prevention Plan (SWPPP). Contact the KDSWCD for questions or assistance in developing a SWPPP (page 13).

Soil Erosion: Many construction sites are required to develop and follow a Stormwater Pollution Prevention Plan (SWPPP) in order to be in compliance with local, state, and federal laws regarding soil erosion and stormwater management. Contact the KDSWCD for questions or assistance in developing a SWPPP (page 13).

Highly Erodible Land: There is Potentially Highly Erodible Land identified on this site (page 14).

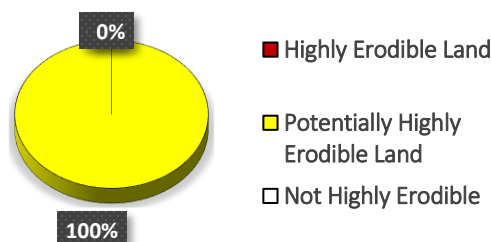

**EXECUTIVE SUMMARY
APPLICATION 24-020
February 26, 2024**

Regulations: Please note that additional permits are required for any development impacting wetlands, streams, or floodplain areas (page 23).

Soil Interpretations: Soils at this site may contain limitations for the proposed use. All information is from the Soil Survey of DuPage County, Illinois. The limiting factors for this site are: **Depth to Saturated Zone, Ponding, Shrink-Swell, Low Strength, Frost Action** (pages 15-20).

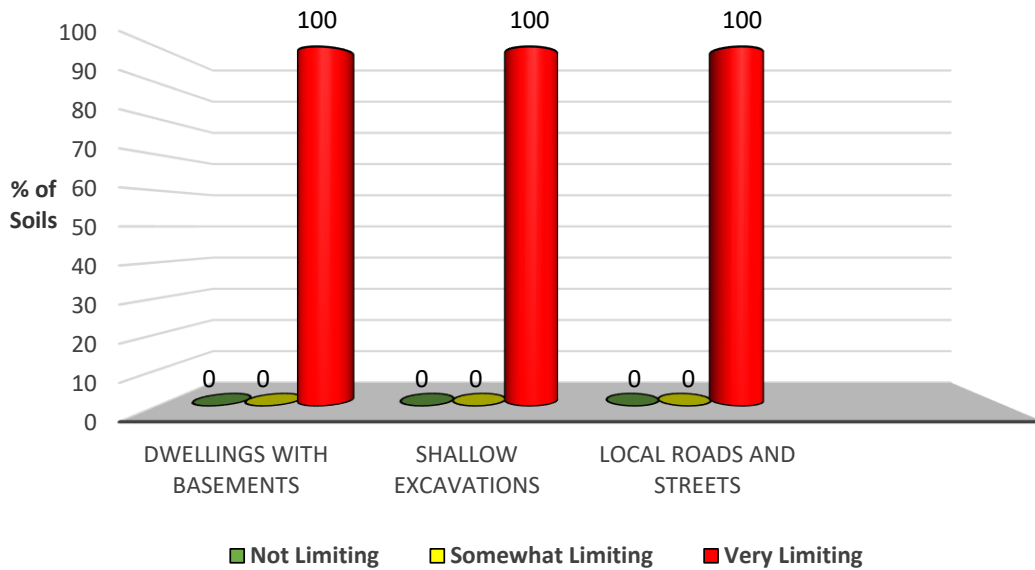

Hydric Soils: There are **no** hydric soils or soils with hydric inclusions identified on this site (page 22).



SITE INSPECTION



Figure 16: Location of site inspection photos

A site inspection was conducted by **Resource Assistant, Isabella Borzeka** on **February 26, 2024**. The following photos were taken during this inspection and reflect the site conditions at that time.

SITE INSPECTION PHOTOS



Photo 1 facing north



Photo 2 facing northwest



Photo 3 facing east



Photo 4 facing south



Photo 5 facing west



Photo 6 facing southeast



NATURAL RESOURCES INVENTORY

24-046

May 16, 2024

Prepared for:
Village of Lombard

Petitioner:
Afsar Developers, LLC
13W733 Butterfield Rd. Ste. F
Oakbrook Terrace, IL 60181

PURPOSE AND INTENT

This Natural Resources Inventory is intended to present the most current natural resource information available for a parcel, lot, or tract of land in an understandable format. It contains a description of the present conditions and resources available and their potential impact on each other, especially in regards to a proposed change to that parcel of land. This information comes from standardized data, investigations of the parcel, and other information furnished by the petitioner. **This report must be read in its entirety**, so that the relationship between natural resource factors and the proposed land use can be fully understood.

This report presents natural resource information to owners, land-managers, officials of local governing bodies, and other decision makers concerning the parcel. Decisions concerning variations, amendments, or relief of local zoning ordinances may reference this report. Also, decisions concerning the future of a proposed subdivision of vacant or agricultural lands, and the subsequent development of these lands may reference this report. This report is a requirement under the State of Illinois Soil and Water Conservation District Act contained in ILCS 70, 405/1 ET seq.

This report provides the best available natural resource information for the parcel and when used properly, will provide the basis for good land use change decisions and proper development while protecting the natural resource base of the county. However, because of the variability of nature, and because of the limitations of map scale and the precision of natural resource maps (which includes

the property boundaries represented for the parcel), this report does not reflect precise natural resource information at specific locations within the parcel. On-site investigations, soil evaluations, and engineering studies should be conducted as necessary, for point-specific information.

This Natural Resources Inventory report is a review of the major natural resources of the site and a general estimate of the suitability of this site for the proposed use. Because of the small size of this parcel and because of the inherent probable errors in the precision of natural resource information at the scale of natural resource maps, the KDSWCD makes no opinion on the suitability of this site for the proposed use but may give general statements and an estimate of the possible effects of the land use change to the natural resources of this parcel. The information given in this report is based on the review of natural resource maps and literature by the Kane-DuPage Soil and Water Conservation District. The statements in this report are not meant as a recommendation for the success, nor the failure of, the proposed use of this parcel.

This report should alert the reader to the capabilities of the parcel and to the possible issues that may occur if the properties and characteristics of the land are ignored. Please direct technical questions about information supplied in this report to:

Kane-DuPage Soil & Water Conservation District
2315 Dean Street, Suite 100
St. Charles, IL 60175
Phone: (630) 584-7960 x3

TABLE OF CONTENTS

PARCEL LOCATION4

LAND COVER IN THE EARLY 1800'S5

NATIONAL WETLAND INVENTORY (NWI)6

DUPAGE COUNTY WETLANDS.....7

FLOODPLAINS8

WATERSHEDS AND STREAMS9

WATERSHEDS AND SUBWATERSHEDS.....10

AQUIFER SENSITIVITY.....11

TOPOGRAPHY AND OVERLAND FLOW.....12

STORMWATER MANAGEMENT13

SOIL EROSION13

HIGHLY ERODIBLE LAND (HEL)14

SOILS & SOIL INTERPRETATIONS15

SOIL SURVEY16

SOIL MAP UNIT DESCRIPTIONS17

SOIL INTERPRETATIONS – DWELLINGS WITHOUT BASEMENTS.....18

SOIL INTERPRETATIONS – SHALLOW EXCAVATIONS19

SOIL INTERPRETATIONS – LOCAL ROADS AND STREETS20

SOIL INTERPRETATIONS – LAWNS AND LANDSCAPING21

WATER TABLE22

HYDRIC SOILS.....23

REGULATORY INFORMATION24

REGULATORY AGENCIES24

CONTACTS25

REFERENCES26

EXECUTIVE SUMMARY27

SITE INSPECTION29

SITE INSPECTION PHOTOS30

TABLE OF FIGURES

FIGURE 1: PLAT MAP WITH AERIAL BACKGROUND AND PARCEL BOUNDARY4

FIGURE 2: LAND COVER OF ILLINOIS IN THE EARLY 1800’S5

FIGURE 3: NATIONAL WETLAND INVENTORY (NWI) MAP.....6

FIGURE 4: DUPAGE COUNTY WETLAND MAP.....7

FIGURE 5: FLOODPLAIN MAP - FEDERAL EMERGENCY MANAGEMENT AGENCY (FEMA)8

FIGURE 6: WATERSHEDS AND SUBWATERSHEDS MAP..... 10

FIGURE 7: AQUIFER SENSITIVITY TO CONTAMINATION MAP 11

FIGURE 8: TOPOGRAPHIC MAP SHOWING CONTOUR LINES 12

FIGURE 9: HIGHLY ERODIBLE LAND MAP 14

FIGURE 10: SOIL SURVEY 16

FIGURE 11: SOIL INTERPRETATIONS FOR DWELLINGS WITHOUT BASEMENTS..... 18

FIGURE 12: SOIL INTERPRETATIONS FOR SHALLOW EXCAVATIONS 19

FIGURE 13: SOIL INTERPRETATIONS FOR LOCAL ROADS AND STREETS 20

FIGURE 14: SOIL INTERPRETATIONS FOR LAWNS AND LANDSCAPING 21

FIGURE 15: MAP SHOWING THE DEPTH TO A SEASONAL HIGH-WATER TABLE..... 22

FIGURE 16: HYDRIC SOILS MAP 23

FIGURE 17: LOCATION OF SITE INSPECTION PHOTOS 29

PARCEL LOCATION

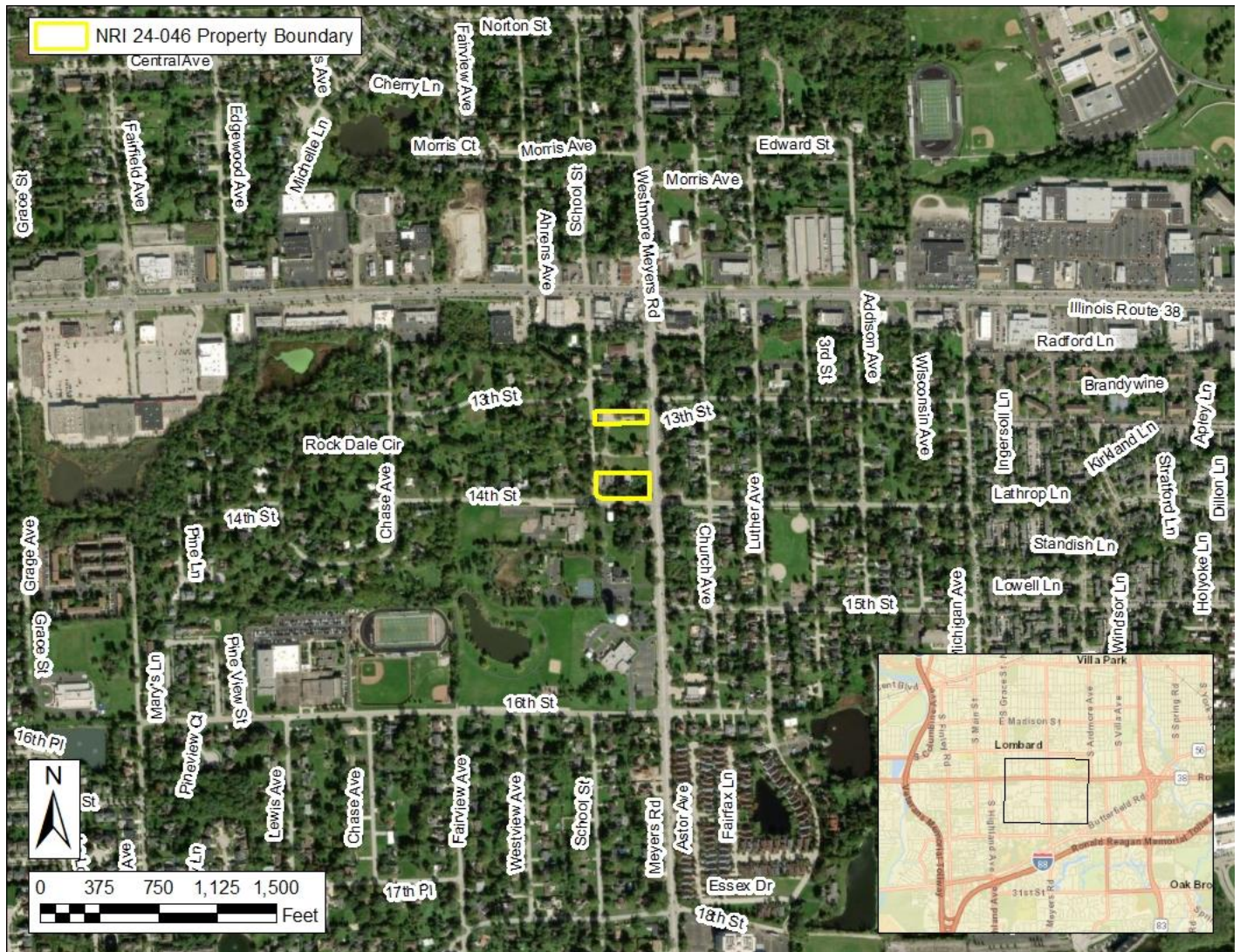

Figure 1: Plat Map with aerial background and parcel boundary

This site is in York Township. The public land survey system identifies the site in **Section 21 in Township 39 North and Range 11 East**. The site is parcel # **06-21-102-010, 06-21-102-014, 06-21-102-028** located at **1308, 1320, & 1330 S. Meyers Rd. in Lombard, IL.**

LAND COVER IN THE EARLY 1800'S

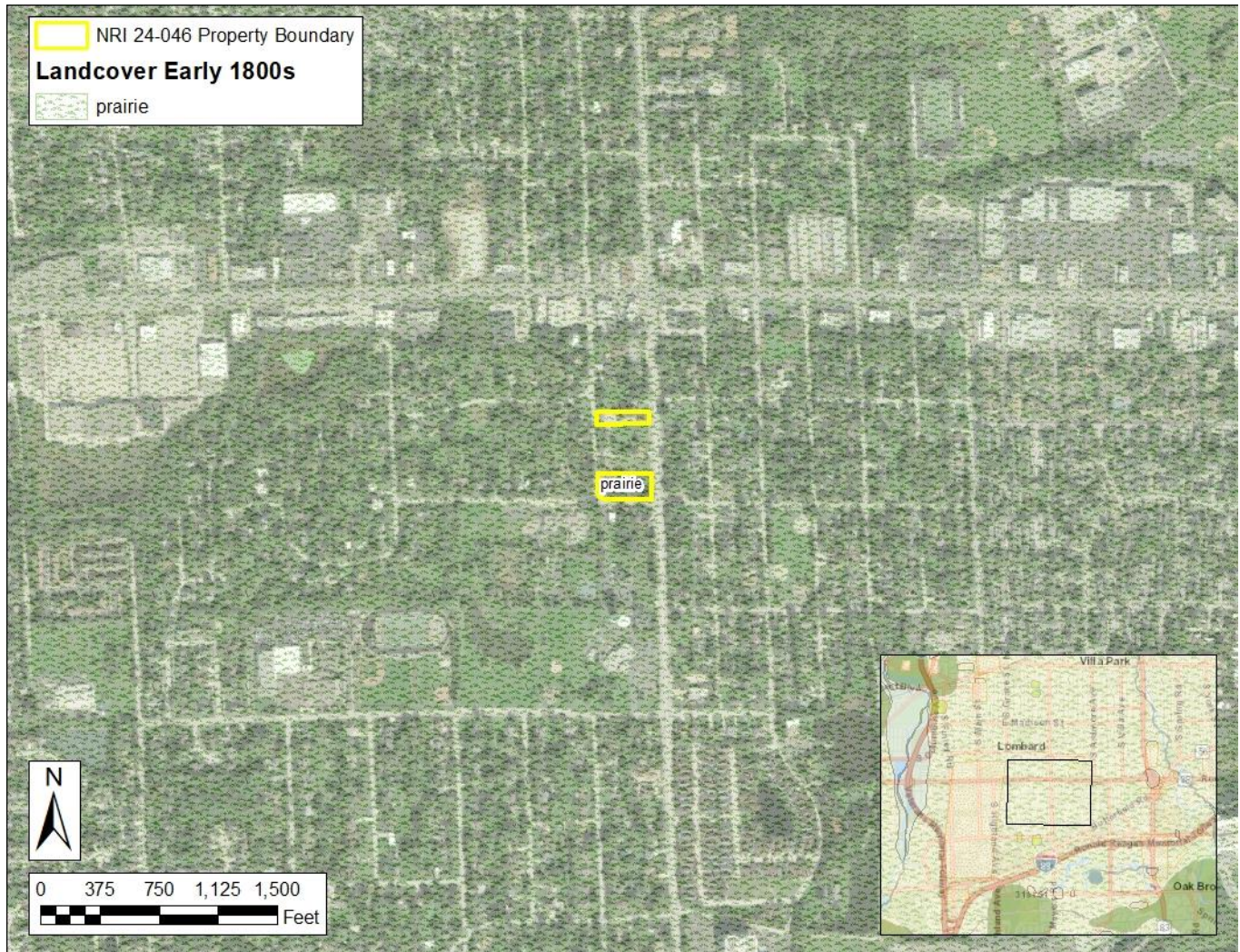

Figure 2: Land Cover of Illinois in the Early 1800's

The public land survey system represents one of the earliest detailed maps for Illinois. The surveys began in 1804 and were largely completed by 1843. The surveyors recorded the land cover and natural resource areas as they worked across the state. These plat maps and field notebooks contain a wealth of information about what the landscape was like before large numbers of settlers came into the state and began modifying the land.

Much of the landscape of Illinois in the early 1800's consisted of two different natural resource areas; prairie and forest. The forest category includes woodlands and savannas, typical of northeastern Illinois. Prairie and forest ecosystems are extremely valuable resources for many reasons. These areas:

- provide wildlife habitat and support biodiversity
- provide areas for recreational opportunities

- improve soil health and reduce soil loss
- improve air and water quality

The original 42 categories of natural resource areas were later simplified to 12 categories; barrens, bottomland, cultural (farms), forest, marsh, other wetlands, prairie, slough, swamp, special geographic features, wet prairie, and water. The maps do not represent exact site conditions, but represent the observations of individual surveyors as they crossed through the area.

This site is recorded as prairie land cover on the early 1800's map. The Kane-DuPage Soil & Water Conservation District recommends preserving as much of the natural character of the site as possible, using native plants for landscaping, and removing and controlling invasive species.

NATIONAL WETLAND INVENTORY (NWI)



Figure 3: National Wetland Inventory (NWI) Map

The National Wetland Inventory (NWI), conducted by the U.S. Fish and Wildlife Service, identifies significant wetlands throughout the country. All U.S. federal agencies define wetlands as follows, “Those areas that are inundated or saturated by surface or ground water at a frequency and duration sufficient to support, and that under normal circumstances do support, a prevalence of vegetation typically adapted for life in saturated soil conditions. Wetlands generally include swamps, marshes, bogs and similar areas.” Other common wetlands located in this part of Illinois are fens, wet meadows, seasonally saturated soils, and farmed wetlands.

Wetlands are protected and regulated by federal, state, and local laws, without regard to size. Wetlands are valuable, productive, and diverse ecological systems and provide multiple benefits, including:

- controlling flooding by slowing the release of excess water downstream or through the soil,

- cleansing water by filtering out sediment and pollutants,
- functioning as recharge areas for groundwater,
- providing essential breeding, rearing, and feeding habitat for many species of wildlife.

A review of the National Wetland Inventory indicates that there are no NWI wetlands on this site. Although the NWI is very thorough, it is not a complete inventory of all possible wetlands. Other regulated wetlands may be present.

The KDSWCD recommends contacting the U.S. Army Corps of Engineers and the DuPage County Stormwater Management Department before commencing any construction activities that may impact wet areas or floodplains. Please see the information on Regulatory Agencies (page 24) for wetland regulation information.

DUPAGE COUNTY WETLANDS



Figure 4: DuPage County Wetland Map

Completed in 2014 and updated periodically, the DuPage County Wetland Initiative was a cooperative effort between DuPage County and the U.S. Environmental Protection Agency to identify the location and quality of the wetlands of DuPage County and to develop wetland protection strategies. This initiative was developed to provide improved awareness of the locations, functions, and values of wetlands and other waters of the United States. The information can be used by federal, state, and local government to aid in zoning, permitting, and land acquisition decisions. In addition, the information can provide data to agencies, landowners, and private citizens interested in restoration or protection of aquatic sites and resources.

For more detailed information regarding wetlands in DuPage County, please refer to the information at: https://www.dupagecounty.gov/government/departments/stormwater_management/stormwater_permitting/special_management_areas/

A review of the DuPage County Wetlands Map revealed that no wetlands were identified on this site.

FLOODPLAINS



Figure 5: Floodplain map - Federal Emergency Management Agency (FEMA)

Undeveloped floodplains provide many natural resources and functions of considerable economic, social, and environmental value. Floodplains often contain wetlands and other important ecological areas as part of a total functioning system that impacts directly on the quality of the local environment.

Here are a few of the benefits and functions of floodplains:

- natural flood storage and erosion control
- water quality maintenance
- groundwater recharge
- nutrient filtration
- biological productivity/wildlife habitat

- recreational opportunities/aesthetic value
- Also, development in a floodplain has a hazardous risk of damage by high flood waters and stream overflow. For this reason, floodplains are generally unsuited to most development and structures.

According to the FEMA Flood Insurance Rate Map, **none** of this site is within the boundaries of a 100-year floodplain. Any development in the floodplain, other than restoration efforts, is generally unsuited and hazardous and will impede the beneficial functions of the floodplain.

Please see the information on Regulatory Agencies (page 24) for information regarding floodplain regulations.

WATERSHEDS AND STREAMS

Watersheds are areas of land that eventually drain into a river or stream. Everyone lives in a watershed, no matter if a river or stream is nearby. Watersheds may be named according to its major river or stream. Watersheds, such as the Mississippi River watershed, may be extremely large, encompassing multiple states. Watersheds may also be subdivided into smaller units, such as subwatersheds. Some very small watersheds may not contain a named stream. However, the water that drains from that watershed eventually reaches a stream or river.

Watersheds in the United States are delineated by the U.S. Geological Survey (USGS) using a nationwide system based on surface hydrologic features.

Examples of these surface hydrologic features include discharge flow, substratum size, stream width, and depth. This USGS system divides the country into 22 regions (2-digit), 245 subregions (4-digit), 405 basins (6-digit), nearly 2,400 subbasins (8-digit), roughly 19,000 watersheds (10-digit), and approximately 105,000 subwatersheds (12-digit). The USGS uses this system to assign each hydrologic area with a hierarchical Hydrologic Unit code (HUC), which consists of 2 additional digits for each level within the hydrologic unit system.

A complete list of Hydrologic Unit codes, descriptions, names, and drainage areas can be found in the [United States Geological Survey Water-Supply Paper 2294](#), entitled "Hydrologic Unit Maps".

Common Watershed Goals:

- Protect and restore natural resources
- Improve water quality
- Reduce flood damage
- Enhance and restore stream health
- Guide new developments to benefit watershed goals
- Preserve and develop green infrastructure
- Enhance education and stewardship

In DuPage County, many watershed plans have already been developed. Please follow the link below to the DuPage County Stormwater Management Watershed Plans.

https://www.dupagecounty.gov/government/departments/stormwater_management/floodplain_mapping/watershed_planning_and_modeling.php

Rivers and Streams are necessary components of successfully functioning ecosystems. It is important to protect the beneficial functions and integrity of our local streams and rivers. Development near stream systems has the potential to increase flooding, especially in urban areas where there is a lot of impervious surfaces and a greater amount of stormwater runoff. Pollution is also an issue for stream systems in urban and rural areas. It is rare for any surface waters to be impacted by only one source of pollution. With few exceptions, every land-use activity is a potential source of nonpoint source water pollution.

The Illinois Environmental Protection Agency (IEPA) provides the following in regard to nonpoint source pollution, "Nonpoint source pollution (NPS) occurs when runoff from rain and snowmelt carries pollutants into waterways such as rivers, streams, lakes, wetlands, and even groundwater. Examples of or sources of NPS pollution in Illinois include runoff from farm fields, livestock facilities, construction sites, lawns and gardens, city streets and parking lots, surface coal mines, and forestry. The major sources of NPS pollution in Illinois are agriculture, urban runoff, and habitat modification."

Nutrient management is of vital importance to the health of our rivers and streams. Nutrient load in our local streams and rivers has contributed to the Gulf of Mexico hypoxia, or a "dead zone" located where the Mississippi River meets the Gulf of Mexico. This dead zone has little to no biological activity. Yearly averages indicate the dead zone to be greater than 5,000 square miles in size. Illinois was required and has introduced a plan to reduce nutrient loss from point source pollution sources, such as wastewater treatment plants and industrial wastewater, as well as nonpoint pollution sources.

Read Illinois's Plan for reducing nutrient loss here:

<https://epa.illinois.gov/topics/water-quality/watershed-management/excess-nutrients/nutrient-loss-reduction-strategy.html>

WATERSHEDS AND SUBWATERSHEDS

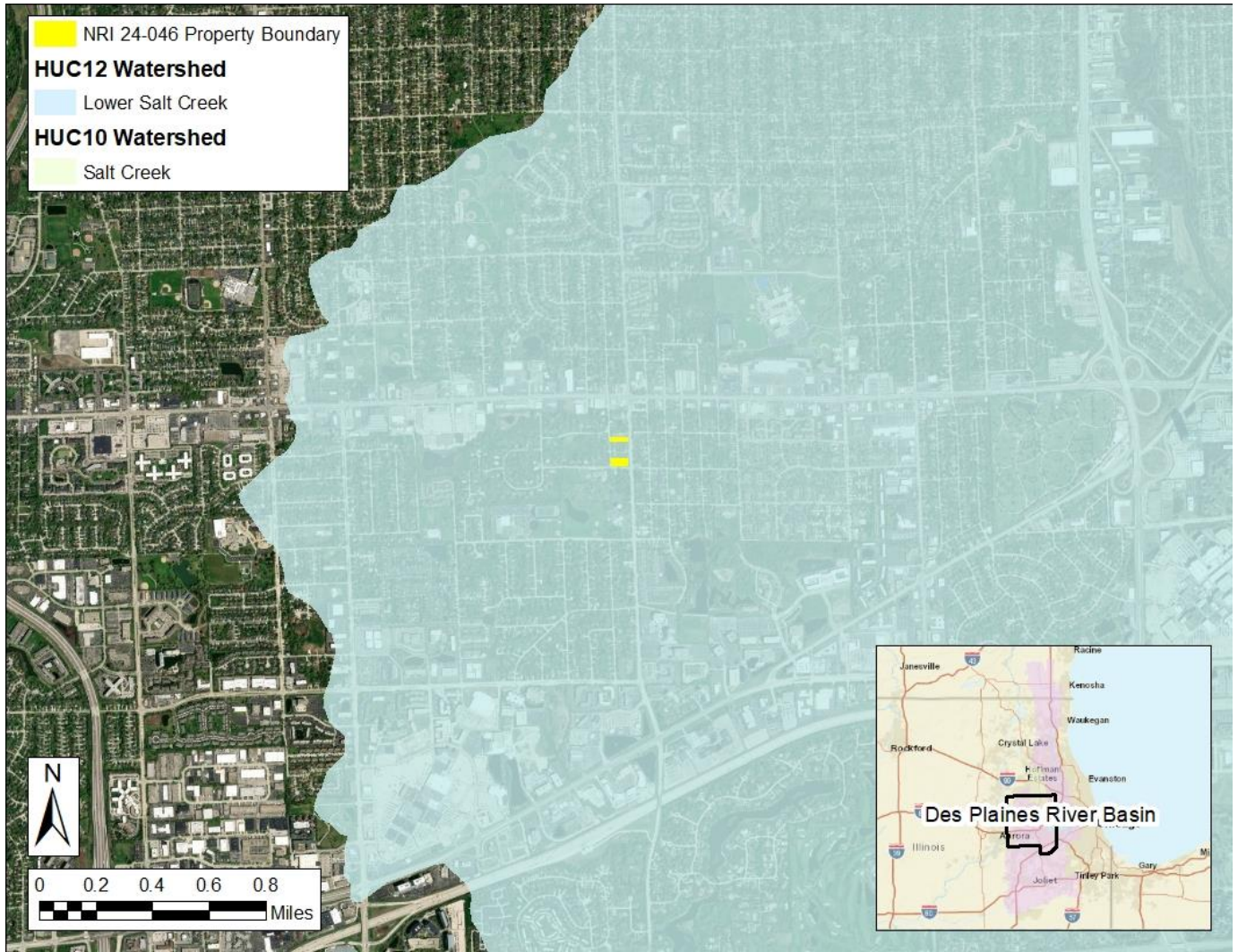

Figure 6: Watersheds and Subwatersheds

DuPage County has been divided into two major watershed subbasins by federal and state agencies, based upon the drainage area of local rivers: the Des Plaines River Subbasin, that covers a majority of DuPage County, and the Lower Fox River Subbasin, that occupies the western portion of the county. These subbasins are part of the Illinois River watershed and part of the greater Mississippi River watershed. Within DuPage County, the Des Plaines River Subbasin is divided into the Willow Creek-Des Plaines River Watershed; the Salt Creek Watershed; the DuPage River Watershed; and the Chicago Sanitary and Ship Canal-Des Watershed. The portion of the Lower Fox River Subbasin in DuPage County is further divided into the Ferson Creek-Fox River Watershed. These watersheds are then divided further into smaller local subwatersheds for planning.

Local watershed management planning is an important effort for the protection of local water resources and can involve watershed organizations, citizens, communities, municipalities, as well as state, local, tribal and/or federal environmental agencies. Water quality is a direct reflection of its watershed.

The map above indicates that 100 percent of this site is located within the boundaries of subwatershed HUC12-071200040404 Lower Salt Creek of the HUC10-0712000404 Salt Creek watershed.

AQUIFER SENSITIVITY

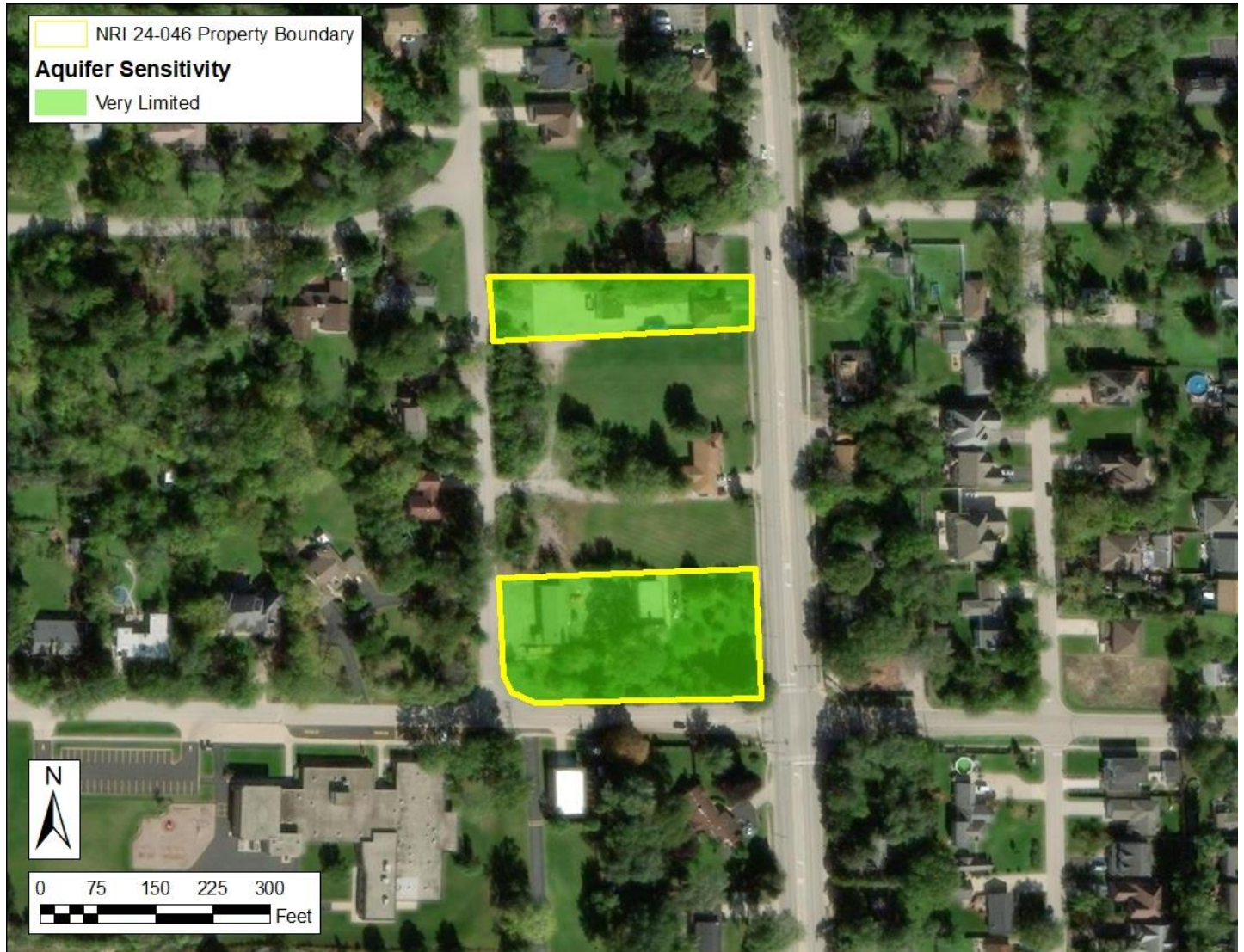

Figure 7: Aquifer sensitivity to contamination map

The U.S. Environmental Protection Agency defines aquifer sensitivity/contamination potential as “a measure of the ease with which a contaminant applied on or near the land surface can migrate to an aquifer.” Aquifers function as a storage area for groundwater recharge, which makes them a reliable source of fresh water. Groundwater from aquifers is a valuable source of drinking water when it remains uncontaminated.

According to the Illinois State Geological Survey, this site lies completely or partially within a zone rated as **very limited** with respect to potential for contamination from spilled or applied substances to the soil surface.

Contact the KDSWCD for references regarding application of chemicals and best management practices to reduce the risk of aquifer contamination from this site.

TOPOGRAPHY AND OVERLAND FLOW



Figure 8: Topographic map showing contour lines

Topographic maps (contour maps) give information on the elevation of the land, which is important to determine slope steepness, natural water flow paths, and watershed information. The natural water flow path can determine where water leaves a property and where it may impact surrounding natural resources. Slope, along with soil erodibility factors, affect the potential of soil erosion on a site. Contour maps can also help determine the areas of potential flooding. It is important to consider the direction of water flow and erosion potential on all construction sites. Areas where water leaves the site should be monitored for sediment and other pollutants, which

could contaminate downstream waters.

The map above shows contour lines with 2 feet elevation distance between each line. The high point of this property is in the southern portion of the site at an elevation of approximately 726 feet above sea level. The property generally drains to the northwest via overland flow. The lowest elevation on the property is approximately 722 feet above sea level.

Please Note: This site’s actual topography does not match the map. The site has been materially altered after the topological map information was gathered and produced.

STORMWATER MANAGEMENT

Managing stormwater and stormwater runoff is critical for all development. Stormwater runoff from a site usually increases as a result of soil compaction, more impervious surfaces, loss of vegetation, and soil degradation during construction activities. Increased runoff causes downstream flooding, soil erosion, sedimentation, and pollution of surface waters. The KDSWCD recommends the use of onsite stormwater management strategies whenever possible. These strategies include: stormwater retention and detention basins; bioswales, raingardens, and the use of natural depressions and vegetated swales; deep-rooted native plants; permeable pavers or permeable asphalt. Combinations of these and other practices may be able to retain stormwater onsite. The Illinois Environmental Protection Agency (IEPA) now

recommends that stormwater pollution prevention plans include post-construction stormwater management to keep as much stormwater on the site, as possible.

Site assessment with soil testing should help to determine what stormwater management practices are best for your site. Insufficient stormwater management has the potential to cause or aggravate flooding conditions on surrounding properties, or elsewhere in the watershed. Please refer to the DuPage County Stormwater Ordinance for stormwater requirements and minimum standards.

https://www.dupagecounty.gov/government/departments/stormwater_management/stormwater_permitting/stormwater_ordinance/

SOIL EROSION

Soil erosion is the degradation of soil, mostly caused by the force of rain and the movement of water detaching soil particles and carrying the soil off the site. Factors that affect soil erosion are the slope of the land, the inherent properties of the soil, and the cover (or lack of cover) on the soil surface. Extra care must be taken to prevent or reduce soil erosion on construction sites containing highly erodible soils.

The potential for soil erosion during and after construction activities could have major impacts, both onsite and offsite. The erosion and resulting sedimentation may become a primary nonpoint source of water pollution. Eroded soil during the construction phase can create unsafe conditions on roadways, degrade water quality, and destroy aquatic ecosystems lower in the watershed. Soil erosion also increases the risk of flooding due to choking culverts, ditches, and storm sewers, and reduces the capacity of natural and man-made detention facilities.

Construction and development activities should include a soil erosion and sedimentation control plan. Erosion and sedimentation control measures include:

- Staging construction to minimize the number of disturbed areas present at the same time
- Keeping the ground covered, either by mulch or vegetation
- Keeping runoff rates minimal

Many construction sites are required to develop and follow a Stormwater Pollution Prevention Plan (SWPPP) in order to be in compliance with local, state, and federal laws regarding soil erosion and stormwater management. Soil erosion and sedimentation control plans, including maintenance responsibilities, should be clearly communicated to all contractors working on the site. Special care must be taken to protect any wetlands, streams, and other sensitive areas.

Please refer to the Illinois Urban Manual for erosion and sediment control information and technical guidance when creating erosion and sediment control plans. The practice standards and standard drawings from the Illinois Urban Manual represent the minimum standard in Illinois. Contact the DuPage County Stormwater Management Department for specific information on permits. Contact the KDSWCD for assistance in preparing a stormwater pollution prevention plan.

HIGHLY ERODIBLE LAND (HEL)



Figure 9: Highly Erodible Land map

Soils vary in their susceptibility to erosion. Highly erodible land (HEL) is land that can erode at excessive rates. Highly erodible land is generally sloping and contains soils that are susceptible to soil erosion by runoff and raindrop impact. The susceptibility to erosion and the highly erodible rating depends upon several factors and properties of the soil. Fine-textured soils high in clay have low erodibility values, because the soil particles are resistant to detachment. Coarse-textured soils, such as sandy soils also have low erodibility values because the water infiltrates and they have less runoff. Medium textured soils, such as loams, are moderately susceptible to detachment and they produce moderate runoff. Soils having a high silt content, like many soils in DuPage County, are the most erodible of all soils. They are easily detached

and they tend to crust and produce large amounts and rates of runoff.

Other factors that affect the erodibility of soils include the force of the rainfall, the steepness and length of the slope of the land, and the amount of organic matter in the surface soil layer.

Highly Erodible Land (HEL) contains soils that have been determined by the USDA Natural Resources Conservation Service (NRCS) to be highly erodible. The HEL determination uses a formula involving the properties previously described, to determine the Soil Erodibility Index. Soils that have a Soil Erodibility Index above a certain value are considered highly erodible or potentially highly erodible. **Soils on this site are considered Potentially Highly Erodible Land (PHEL) by the NRCS.**

SOILS & SOIL INTERPRETATIONS

Soils are the foundation of life. Soil is a dynamic ecosystem comprised of living things: plants, animals, and microscopic organisms. Soil is also a substance composed of various minerals and organic matter, interfused with lots of pore spaces which help move and store air and water. Soils are formed over hundreds and thousands of years, taking about 500 years to form an inch of topsoil. Soil is formed by the influences of climate, organisms (plants and animals), topography, the material in which it is developing (parent material), and time. There are thousands of soil series in the world. In Illinois alone, there are over 600 different soil series. Each soil series is unique in its content and its behavior for a particular use.

The different soils across the U.S. have been mapped and identified by the USDA Natural Resources Conservation Service (NRCS) in a soil survey. The soil map of this area (Figure 10: Soil Survey) indicates different soil map units. Each soil map unit and corresponding symbol represent a phase of a soil series. Phases include slope, erosion, flooding frequency, etc. of each soil. Each soil and associated phase have strengths and limitations for a variety of land uses such as septic systems, buildings site development, local roads, and many other uses.

See the Soil Map Units Table in the Soil Survey section for the composition of soil map units of the site. See the Soil Interpretations section for the soil interpretations for the proposed use of the site.

How soil is managed as a resource can be either beneficial or detrimental for the environment, or for any other particular use. It is difficult to change the inherent properties of soil, such as the mineral composition or the amount of sand, silt, or clay within soil. However, it is easy to compact or erode soil to the extent that many soil functions, such as water storage, infiltration, rooting medium, carbon storage, and soil health could all become compromised or destroyed. Management techniques to protect the integrity and functions of soil include:

- limiting traffic on the site to reduce compaction of the soil surface
- keeping the soil covered as much as possible, with deep rooted grasses or with mulch or other erosion control practices

- disturbing only the areas necessary for the footprint of structures and reducing or eliminating mass grading of sites

Soils and Onsite Waste Disposal

Soils are often used for onsite waste disposal or underground septic systems to dispose of sewage, especially for individual homes that are not connected to a municipal sewage system. No interpretive rating is given in this report for on-site wastewater disposal (septic systems). The detail of the soil information in the soil survey is not precise enough to determine suitability for the small area required for a septic system.

A Certified Professional Soil Classifier, in cooperation with the county department of public health, must conduct a soil evaluation to determine the suitability of the parcel for on-site wastewater disposal (i.e., septic system), as required by the State of Illinois.

Soil Interpretation Ratings

The soil interpretation (limitation) ratings are used mainly for engineering designs for proposed uses, such as dwellings with or without basements, local streets and roads, small commercial buildings, etc. The ratings given are based on NRCS national criteria and are defined and used as follows:

Not Limited – This limitation rating indicates that the soil properties are generally favorable for the specified use and that any limitations are minor and easily overcome.

Somewhat Limited - This rating indicates that the soil properties and site features are unfavorable for the specified use, but that the limitations are moderate and can be overcome or minimized with special planning and design.

Very Limited - This indicates that one or more soil properties have severe limitations and are very unfavorable and difficult to overcome. A major increase in construction effort, special designs, or intensive maintenance is required. These costly measures may not be feasible for some soils that are rated as Very Limited.

Contact the KDSWCD for questions concerning soil and refer to the **Illinois Urban Manual** for best management practices for protecting soil.

SOIL SURVEY

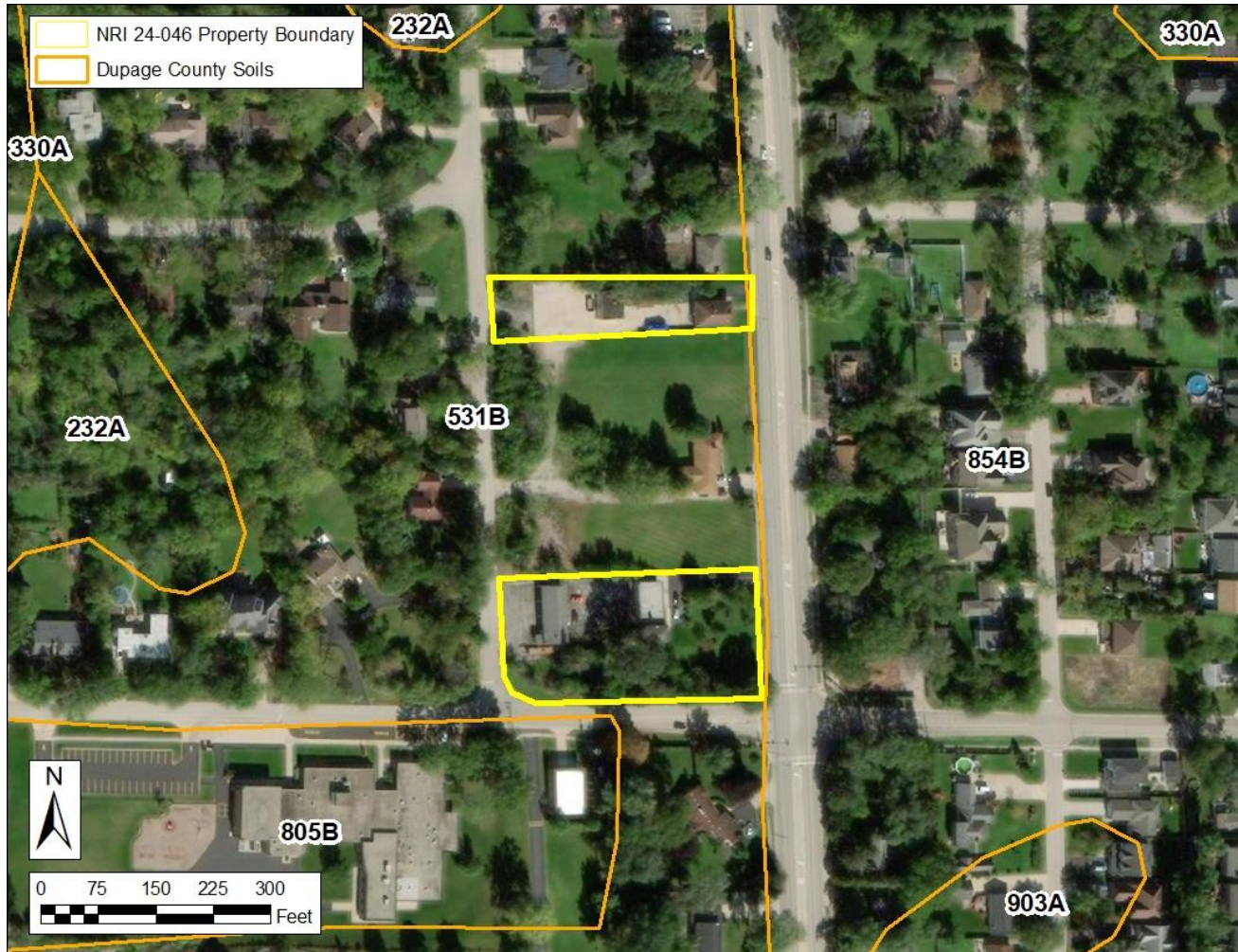

Figure 10: Soil Survey

The soil map unit symbol consists of a combination of numbers and letters which represent the interpretive phase of a soil series for an area of the landscape. Areas within the line of that symbol will have similar soil properties and interpretations.

Table 1: Soil Map Units

SOIL MAP UNIT SYMBOL	PERCENT OF PARCEL	ACRES
531B – Markham	100%	1.85
Total		1.85

All percentages and acreages are approximate.

The soil map in this report has been enlarged beyond the original scale. Enlargement of this map may cause misunderstanding of the accuracy and

precision of the mapping. When enlarged, maps do not show the small areas of contrasting soil that could have been identified if the mapping was completed at a larger scale. The depicted soil boundaries and interpretations derived from the map units do not eliminate the need of onsite sampling, testing, and detailed study of specific sites for intensive uses. Thus, this map and its interpretations are intended for planning purposes only.

The KDSWCD suggests to contact a certified professional soil classifier to conduct an onsite investigation for point-specific soil information to determine the capabilities and the limitations of the soil for a specific use.

SOIL MAP UNIT DESCRIPTIONS

The map units delineated on the detailed soil map in a soil survey represent the soils or miscellaneous areas in the survey area. The map unit descriptions in the report, along with the map, can be used to determine the composition and properties of a unit.

A map unit delineation of a soil map represents an area dominated by one or more major kinds of soil or miscellaneous area. A map unit is identified and named according to the taxonomic classification of the dominant soils. Within a taxonomic class there are precisely defined limits for the properties of the soils. On the landscape, however, the soils are

natural phenomena, and they have the characteristic variability of all natural phenomena. Thus, the range of some observed properties may extend beyond the limits defined for a taxonomic class. The scale of the maps limits the detail that can be shown. Areas of soils of a single taxonomic class rarely, if ever, can be mapped without including areas of other taxonomic classes. Consequently, every map unit is made up of soils or miscellaneous areas for which it is named and some minor components that belong to taxonomic classes other than those of the major soils. These minor components are inclusions within the named map unit.

LIST OF MAP UNITS

531B Markham silt loam, 2 to 4 percent slopes

SOIL INTERPRETATIONS – Dwellings without Basements



Figure 11: Soil Interpretations for Dwellings without Basements

Dwellings are single-family houses of three stories or less. For dwellings without basements, the foundation is assumed to consist of spread footings of reinforced concrete built on undisturbed soil at a depth of maximum frost penetration.

The ratings for dwelling are based on the soil properties that affect the capacity of the soil to support a load without movement and on the properties that affect excavation and construction costs. The properties that affect the load-supporting capacity include depth to water table, ponding, flooding, subsidence, linear extensibility (shrink-swell potential), and compressibility. Compressibility is inferred from the Unified classification of the soil.

These properties include water table, ponding, flooding, slope, depth to rock, and the amount of rock fragments. **The high-water table is often a limiting factor in DuPage County.**

Areas not shaded represent NOT LIMITED, and good performance and very low maintenance can be expected. Yellow represents SOMewhat LIMITED, and fair performance and moderate maintenance can be expected. Red represents VERY LIMITED, and poor performance and high maintenance are to be expected.

See the preceding **Soils Section** for more information concerning soil limitations.

SOIL INTERPRETATIONS – Shallow Excavations



Figure 12: Soil Interpretations for Shallow Excavations

Shallow excavations are trenches or holes dug to a maximum depth of 5 or 6 feet for graves, utility lines, open ditches, or other purposes. The ratings are based on the soil properties that influence the ease of digging and the resistance to sloughing. Depth to bedrock, hardness of bedrock, the amount of large stones, and dense layers influence the ease of digging, filling, and compacting. Depth to the seasonal high-water table, flooding, and ponding may restrict the period when excavations can be made. Slope influences the ease of using machinery. Soil texture, depth to the water table, and linear extensibility (shrink-swell potential) influence the

resistance to sloughing. **The high-water table is often a limiting factor in DuPage County.**

Areas not shaded represent NOT LIMITED, and good performance and very low maintenance can be expected. Yellow represents SOMEWHAT LIMITED, and fair performance and moderate maintenance can be expected. Red represents VERY LIMITED, and poor performance and high maintenance are to be expected.

See the preceding Soils Section for more information concerning soil limitations.

SOIL INTERPRETATIONS – Local Roads and Streets



Figure 13: Soil Interpretations for Local Roads and Streets

Local roads and streets have an all-weather surface and carry automobile and light truck traffic all year. They have a subgrade of cut or fill soil material; a base of gravel, crushed rock, or soil material stabilized by lime or cement; and a surface of flexible material (asphalt), rigid material (concrete), or gravel with a binder.

The ratings are based on the soil properties that affect the ease of excavation and grading and the traffic-supporting capacity. The properties that affect the ease of excavation and grading are depth to bedrock or a cemented pan, hardness of bedrock or a cemented pan, depth to a water table, ponding, flooding, the amount of large stones, and slope. The properties that affect the traffic-supporting capacity

are soil strength (as inferred from the AASHTO group index number), subsidence, linear extensibility (shrink-swell potential), the potential for frost action, depth to a water table, and ponding. **The high-water table is often a limiting factor in DuPage County.**

Areas not shaded represent NOT LIMITED, and good performance and very low maintenance can be expected. Yellow represents SOMEWHAT LIMITED, and fair performance and moderate maintenance can be expected. Red represents VERY LIMITED, and poor performance and high maintenance are to be expected.

See the preceding **Soils Section** for more information concerning soil limitations.

SOIL INTERPRETATIONS – Lawns and Landscaping



Figure 14: Soil Interpretations for Lawns and Landscaping

Lawns and landscaping require soils on which turf and ornamental trees and shrubs can be established and maintained. Irrigation is not considered in the ratings. The ratings are based on the soil properties that affect plant growth and trafficability after vegetation is established. The properties that affect plant growth are pH (acidic or alkaline conditions); depth to a water table; ponding; depth to bedrock; the available water capacity in the upper 40 inches; and the content of calcium carbonate. The properties that affect trafficability are flooding, depth to a water table, ponding, slope, stoniness, and the amount of sand, clay, or organic matter in the

surface layer. **The high-water table is often a limiting factor in DuPage County.**

Areas not shaded represent NOT LIMITED, and good performance and very low maintenance can be expected. Yellow represents SOMEWHAT LIMITED, and fair performance and moderate maintenance can be expected. Red represents VERY LIMITED, and poor performance and high maintenance are to be expected.

See the preceding **Soils Section** for more information concerning soil limitations.

WATER TABLE



Figure 15: Map showing the depth to a seasonal high-water table

A seasonal high-water table, or the depth to a zone saturated with water in the soil during the wet season (typically spring through early summer), is present in most soils in DuPage County, as it is in much of Illinois. The relatively low relief and flat landscape of the region slows the dissipation of water from the soil. This saturated zone fluctuates throughout the year and is closer to the surface in the spring and drops to deeper levels during summer and fall. Soils that are lower on the landscape are generally wetter than those soils higher on the landscape or on more sloping landscape positions. Some soils, especially those in landscape depressions and low-lying areas, have a water table above the soil surface. Water that occurs above the soil surface is considered “ponded” water. Ponding is different from flooding, as the water in ponded areas comes from water rising from below the soil surface or from runoff from adjacent areas. Flooding comes from the overflow of water from rivers and streams. The duration of the seasonal high-water table may have been altered by artificial drainage systems,

especially those areas in cropland or former cropland. Even when soils are artificially drained, they will likely retain wet characteristics and the wetness will be difficult to eliminate entirely. However, artificial drainage may shorten the duration of the seasonal high-water table.

The wetness from the seasonal high-water table is a limiting property of the soil for many uses, especially homesites with or without basements, septic absorption fields, commercial buildings, and roads and streets. Most sites that are zoned for construction will require improved drainage, sump pumps, foundation drains, and other management practices to reduce the wetness. Any change to the natural drainage of the site has the potential to create flooding issues downstream from the site, so use caution in installing drainage systems.

The Soil Survey indicates a seasonal high-water table at a depth of 2.49 feet of the soil surface during the spring and early summer in most years, on the wettest soils of the site.

HYDRIC SOILS



Figure 16: Hydric Soils map

Hydric Soils are wet soils that have a water table near the surface or above the surface, mostly in the spring and summer. The wetness is often a result of being on a lower position on the landscape. Many areas of hydric soils have been altered by artificial drainage systems. Even though they may have artificial drainage, they are still considered to meet the definition of a hydric soil. Although not all hydric soils are considered wetlands, hydric soils are a component of wetlands.

Even when hydric soils are artificially drained, they will likely retain wet characteristics and the wetness will be difficult to eliminate entirely. However, artificial drainage may shorten the duration of the seasonal high-water table. Most sites will require improved drainage, sump pumps, and other management practices to reduce the wetness. Any

change to the natural drainage of the site has the potential to create flooding issues on and adjacent to the site, so use caution in installing drainage systems. Some hydric soils are dominated by organic material (peat or muck) instead of mineral soil material and are not suitable construction sites, because of the low strength of the organic deposits. **Organic soils are extremely difficult to modify for other uses.**

Hydric inclusions are small areas (inclusions) of hydric soils in the lower positions of a landscape dominated by higher, nonhydric soils and these inclusions are not identified on the soil map, given the map scale. However, hydric inclusions may still have a significant impact on your site.

The Soil Survey indicates that no hydric soils or soils with hydric inclusions are indicated on this site.

REGULATORY INFORMATION

Wetlands, Rivers, Streams, and Other Waters: The laws of the United States, the State of Illinois, and local governments assign certain agencies specific and different regulatory roles to protect the waters within their jurisdictional boundaries. These roles include protection of navigation channels and harbors, protection against floodway encroachment, maintenance and enhancement of water quality, protection of fish and wildlife habitat, and protection of recreational resources. Unregulated use of waters could permanently destroy or alter the character of these valuable resources and adversely impact the public. Contact the proper regulatory authorities when planning any work associated with floodplains, wetlands, or other waters so that proper consideration and approval can be obtained.

Wetland and/or Floodplain Permit: Anyone proposing to dredge, fill, riprap, or otherwise alter the banks or beds of a floodplain or floodway; or construct, operate, or maintain any dock, pier, wharf, sluice, dam, piling, wall, fence, utility of a lake, stream, or river subject to federal, state, or local regulatory jurisdiction should apply for agency approvals.

Construction Permit: Anyone disturbing an acre or more of land during proposed construction activities should apply for the NPDES General Construction Permit ILR10. Building and stormwater permits should also be obtained locally from municipal government and/or DuPage County.

REGULATORY AGENCIES

Wetlands, Floodplains, Streams, & Other Waters:

U.S. Army Corps of Engineers, Chicago District,
111 North Canal Street
Chicago, IL 60606-7206
(312) 353-6400
<http://www.lrc.usace.army.mil/>

DuPage County Stormwater Management Department

Jack T. Knuepfer Administration Building
421 N. County Farm Road
Wheaton, IL 60187
(630) 407-6700
https://www.dupagecounty.gov/government/departments/stormwater_management/

Illinois Department of Natural Resources, Office of Water Resources

2050 W. Stearns Road
Bartlett, IL 60103
(847)608-3100
<https://dnr.illinois.gov/waterresources/programs.html>

NPDES General Construction Permit ILR10

Illinois Environmental Protection Agency, Division of Water Pollution Control
1021 North Grand Avenue East
P.O. Box 19276
Springfield, Illinois 62794
(217)782-0610
<https://www2.illinois.gov/epa/topics/forms/water-forms/Pages/default.aspx>

The KDSWCD recommends early coordination with the regulatory agencies BEFORE finalizing work plans. This allows the agencies to recommend measures to mitigate or compensate for adverse impacts. Also, the agency can make possible environmental enhancement provisions early in the project planning stage. This could reduce time required to process necessary approvals. Please be advised that failure to coordinate with regulatory agencies could result in project shut down, fines and/or imprisonment.

CONTACTS**STATE AGENCIES****Illinois Department of Natural Resources**

1 Natural Resources Way
Springfield, Illinois 62702-1271
(217)782-6302

Illinois Department of Transportation

2300 South Dirksen Parkway
Schaumburg, Illinois 62764-0001
(217)782-7820/(800)452-4368

Illinois Environmental Protection Agency

1021 North Grand Avenue East
P.O. Box 19276
Springfield, Illinois 62794-9276
(217)782-3397

Illinois Natural History Survey

1816 South Oak Street MC652
Champaign, Illinois 61820
(217)333-6880

COUNTY / LOCAL OFFICES**DuPage County Government Center**

Jack T. Knuepfer Administration Building
421 N. County Farm Road
Wheaton, IL 60187
630-407-6500

DuPage County Building & Zoning Department

(630) 407-6700

Department of Stormwater Management

(630) 407-6700

Forest Preserve District of DuPage County

3580 Naperville Road
Wheaton, IL 60189
(630) 933-7200

DuPage County Health Department

111 N County Farm Road
Wheaton, IL 60187
Phone: 630-682-7400

Kane-DuPage Soil and Water Conservation District

2315 Dean Street Suite 100
St. Charles, Illinois 60175
(630) 584-7960 ext. 3

FEDERAL AGENCIES**U. S. Army Corps of Engineers**

Regulatory Branch
231 S LaSalle Street, Suite 1500
Chicago, Illinois 60604
(312)846-5330
<http://www.usace.army.mil>

U.S. Environmental Protection Agency

Region 5
77 West Jackson Boulevard
Chicago, Illinois 60604
(312)353-2000 or (800)621-8431
<http://www.epa.gov/region5/>

U.S. Fish & Wildlife Service

Chicago Illinois Field Office
230 South Dearborn Suite 2938
Chicago, IL 60604
(847)298-3250
<http://www.fws.gov/>

U.S.D.A. Natural Resources Conservation Service

2315 Dean Street Suite 100
St. Charles, Illinois 60175
(630)584-7960 ext. 3
<http://www.il.nrcs.usda.gov/>

REFERENCES

- Berg, Richard C, Aquifer Sensitivity Classification for Illinois Using Depth to Uppermost Aquifer Material and Aquifer Thickness, Cir. 560, 2001, Illinois State Geological Survey
- Department of Energy and Natural Resources, Illinois State Geological Survey: Potential for Agricultural Chemical Contamination of Aquifers in Illinois: 1995 Revision Environmental Geology 148
- Service Layer Credits Source: Esri, DigitalGlobe, GeoEye, Earthstar Geographics, CNES/Airbus DS, USDA, USGS, AeroGRID, IGN, and the GIS User Community
- Illinois Department of Natural Resources, Ecological Compliance Assessment Tool.
- Illinois Department of Natural Resources, Illinois Natural History Survey, Land Cover of Illinois in the Early 1800s., Vector Digital Data, Version 6.0, August, 2003.
- Illinois Environmental Protection Agency, Nonpoint Source Pollution – What’s It All About, 2015
- Soil Survey Staff, Natural Resources Conservation Service, United States Department of Agriculture. Web Soil Survey. Available online at the following link: <https://websoilsurvey.sc.egov.usda.gov/>. Accessed on the date of this report.
- U.S. Dept. of Homeland Security, Federal Emergency Management Agency, National Flood Insurance Program, Q3 Flood Data, 2011
- U.S. Dept of the Interior, Fish and Wildlife Service, National Wetlands Inventory, Photo Year 1983- 1984, Digitized 1985-1986
- U.S. Geological Survey, Illinois Digital Orthophoto Quadrangles, 2006 photos, Published: Champaign, Illinois State Geological Survey, 2006
- U.S. Geological Survey, Water Supply Paper 2294, Hydrologic Unit Maps. 1994
- <https://pubs.usgs.gov/wsp/wsp2294/>
- Wetlands of DuPage County, Illinois
- <http://gis.dupageco.org/arcgis/rest/services/OpenData>
- 2015 DuPage County, Illinois

EXECUTIVE SUMMARY
APPLICATION 24-046
May 16, 2024

Petitioner: Afsar Developers, LLC, 17W733 Butterfield Rd., Ste. F, Oakbrook Terrace, IL 60181

Contact Person: Mark W. Daniel, 630-833-3311/312-927-0177

Unit of Government Responsible for Permits: DuPage County

Acreage: 1.85

Area of Disturbance (acreage): 1.85

Location of Parcel: Township 39N, Range 11E, Section 21

Property Address/PIN#: #06-21-102-010, 06-21-102-014, 06-21-102-028, 1308, 1320, & 1330 S. Meyers Rd. Lombard, IL 60148

Existing Land Use: Residential/Commercial

Proposed Land Use: Single Family Residential

NATURAL RESOURCE CONCERNS

Land Cover in the Early 1800's: This site is in an area previously identified as **prairie (page 5)**.

Wetlands: The National Wetland Inventory map and the DuPage County Wetlands map **do not** identify wetland areas on this site. If there are any indications of unidentified wetlands on this site, noticed during the proposed land use change, contact the appropriate county and federal wetland regulatory agencies (**pages 6-7**).

Floodplain: There are **no** floodplain areas identified on this site (**page 8**).

Streams: There are **no** streams on this site (**page 9**).

Watersheds and Subwatersheds: The map above indicates that **100** percent of this site is located within the boundaries of subwatershed HUC12-071200040404 **Lower Salt Creek** of the HUC10-0712000404 **Salt Creek** watershed (**page 10**).

Aquifer Sensitivity: This site is classified as having a **very limited** for aquifer contamination (**page 11**).

Topography and Overland Flow: The high point of this property is in the **southern** portion of the site at an elevation of approximately **726** feet above sea level. The property generally drains to the **northeast** via overland flow. The lowest elevation on the property is approximately **722** feet above sea level (**page 12**).

Please Note: This site's actual topography does not match the map. The site has been materially altered after the topological map information was gathered and produced.

Stormwater Management: This site **may or may not** need a Stormwater Pollution Prevention Plan (SWPPP). Contact the KDSWCD for questions or assistance in developing a SWPPP (see **page 13**).

Soil Erosion: Many construction sites are required to develop and follow a Stormwater Pollution Prevention Plan (SWPPP) in order to be in compliance with local, state, and federal laws regarding soil erosion and stormwater management. Contact the KDSWCD for questions or assistance in developing a SWPPP (**page 13**).

EXECUTIVE SUMMARY
APPLICATION 24-046
May 16, 2024

Highly Erodible Land: There is **Potentially Highly Erodible Land** identified on this site (**page 14**).

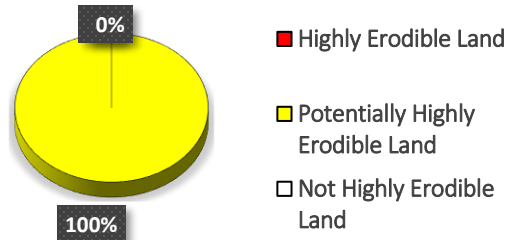

Regulations: Please note that additional permits are required for any development impacting wetlands, streams, or floodplain areas (**page 24**).

Soil Interpretations: Soils at this site may contain limitations for the proposed use. All information is from the Soil Survey of DuPage County, Illinois. The limiting factors for this site are: **Ponding, Depth to Saturated Zone, Shrink-Swell, Low Strength, Frost Action, Droughty, Too Clayey** (**pages 15-21** and attached Soils Tables on **page 16**).

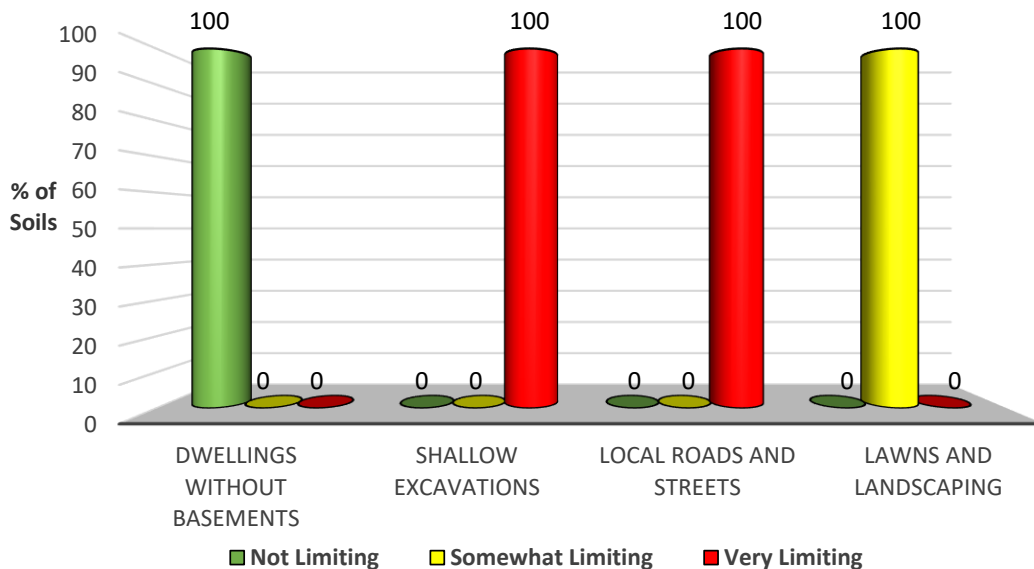

Water Table: There is a seasonal high-water table at a depth of **2.49** feet of the soil surface (**page 22**).

Hydric Soils: There are **no hydric soils or soils with hydric inclusions** identified on this site (**page 23**).



SITE INSPECTION



Figure 17: Location of site inspection photos

A site inspection was conducted by **Resource Assistant, Isabella Borzeka** on **May 16, 2024**. The following photos were taken during this inspection and reflect the site conditions at that time.

SITE INSPECTION PHOTOS



Photo 1 facing east



Photo 2 facing southeast



Photo 3 facing west



Photo 4 facing northeast



Photo 5 facing west



Photo 6 facing east

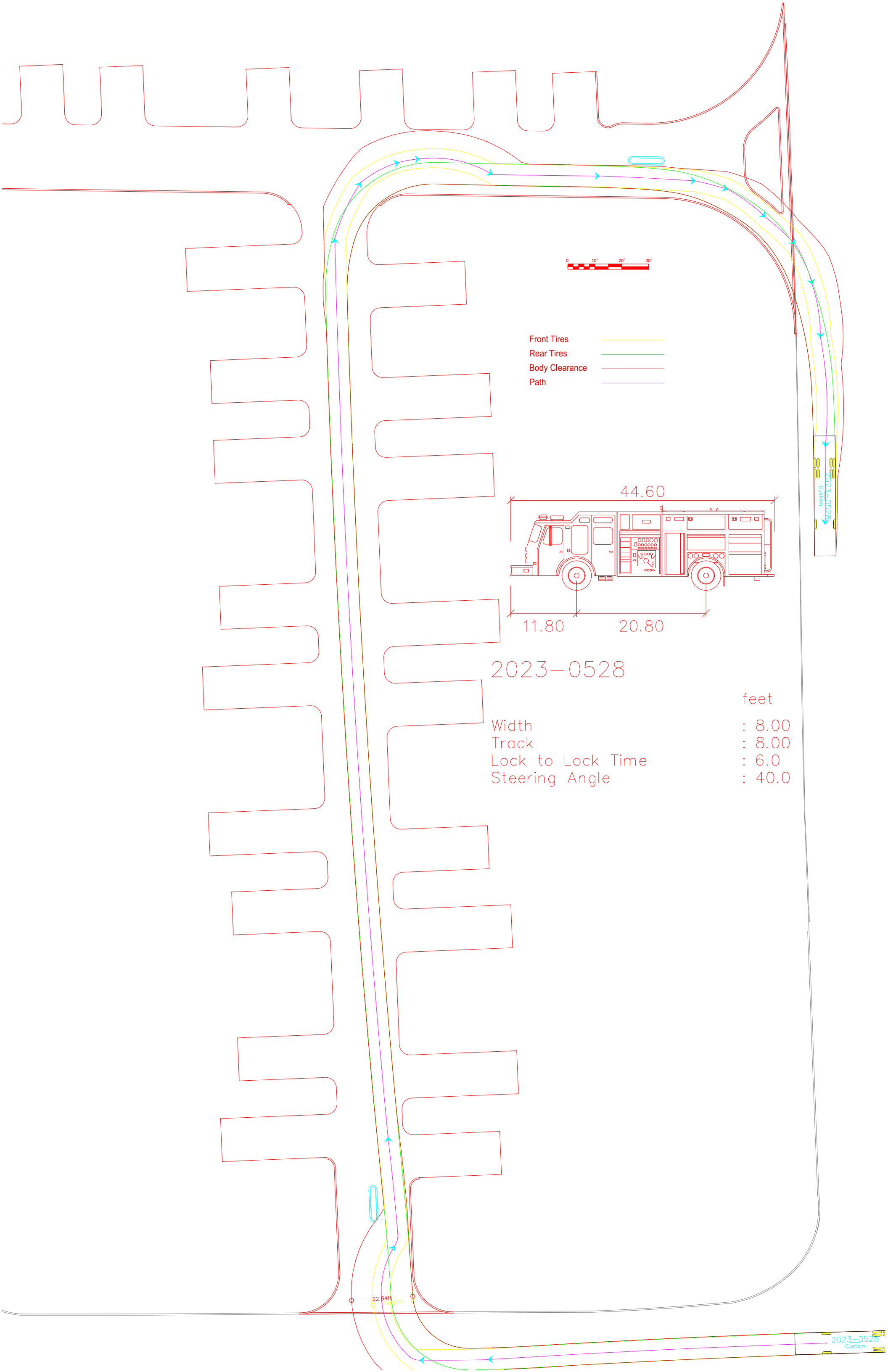

- Front Tires ————
- Rear Tires ————
- Body Clearance ————
- Path ————

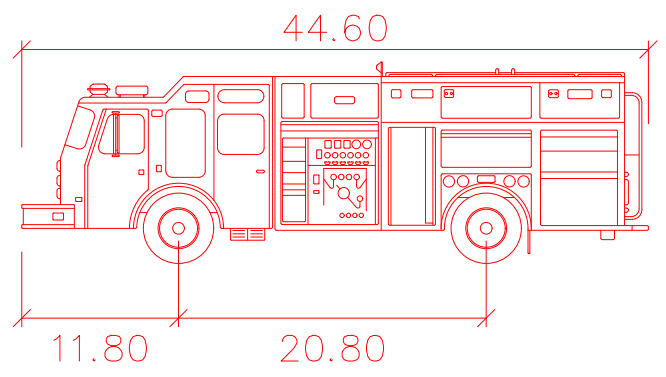

2023-0528

	feet
Width	: 8.00
Track	: 8.00
Lock to Lock Time	: 6.0
Steering Angle	: 40.0

2023-0528
Custom

2023-0528
Custom

22.84ft
14.87ft

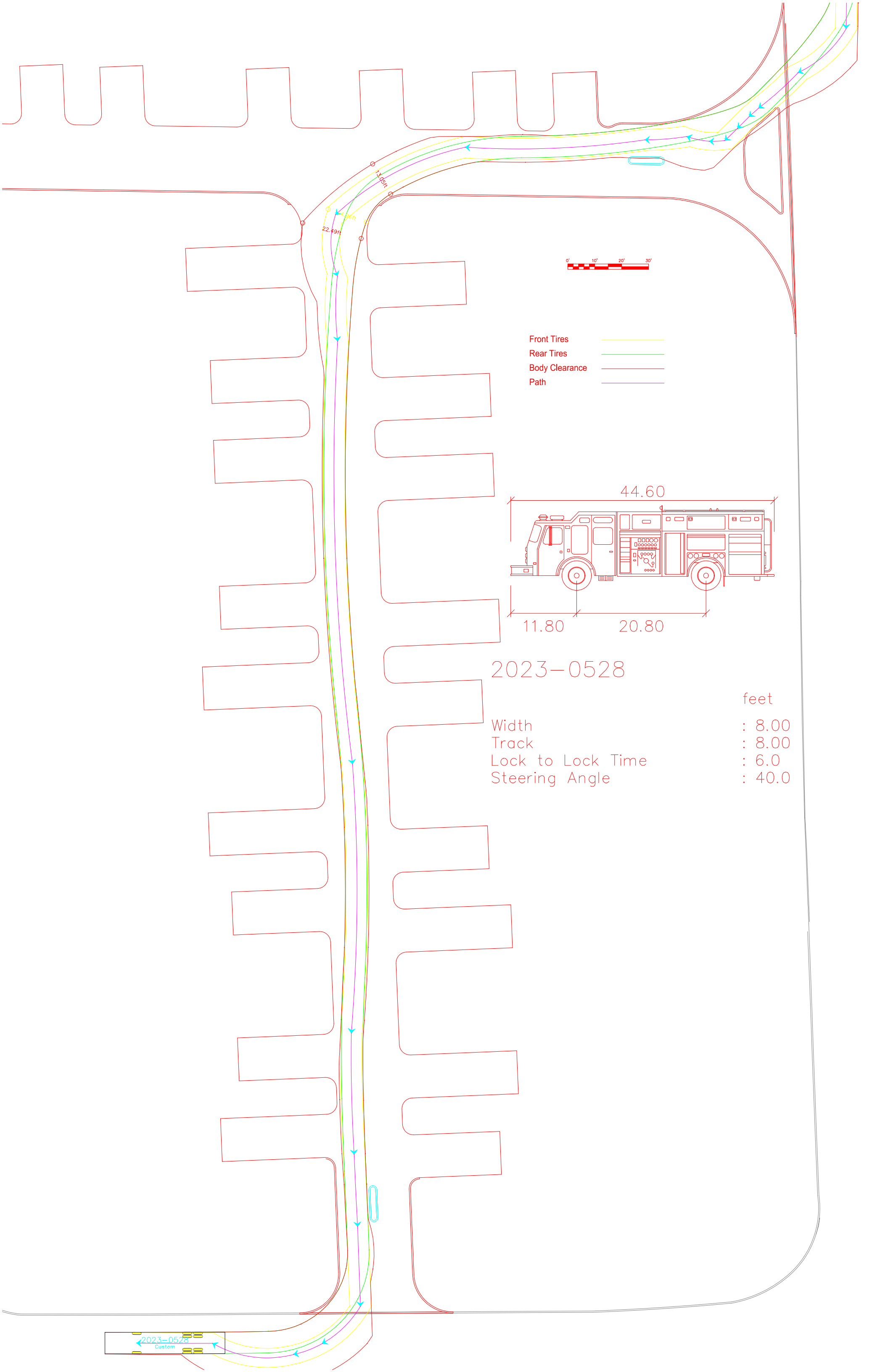

- Front Tires ————
- Rear Tires ————
- Body Clearance ————
- Path ————

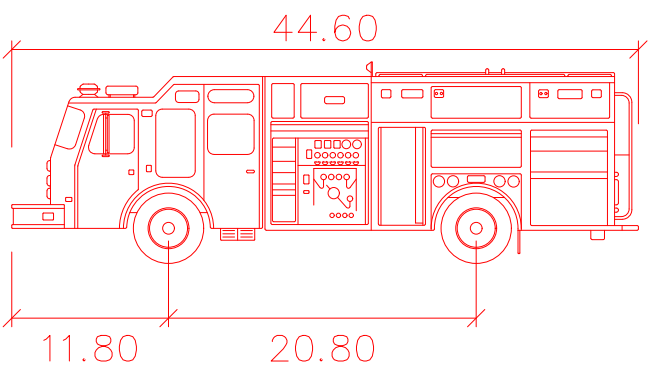

2023-0528

feet
 Width : 8.00
 Track : 8.00
 Lock to Lock Time : 6.0
 Steering Angle : 40.0

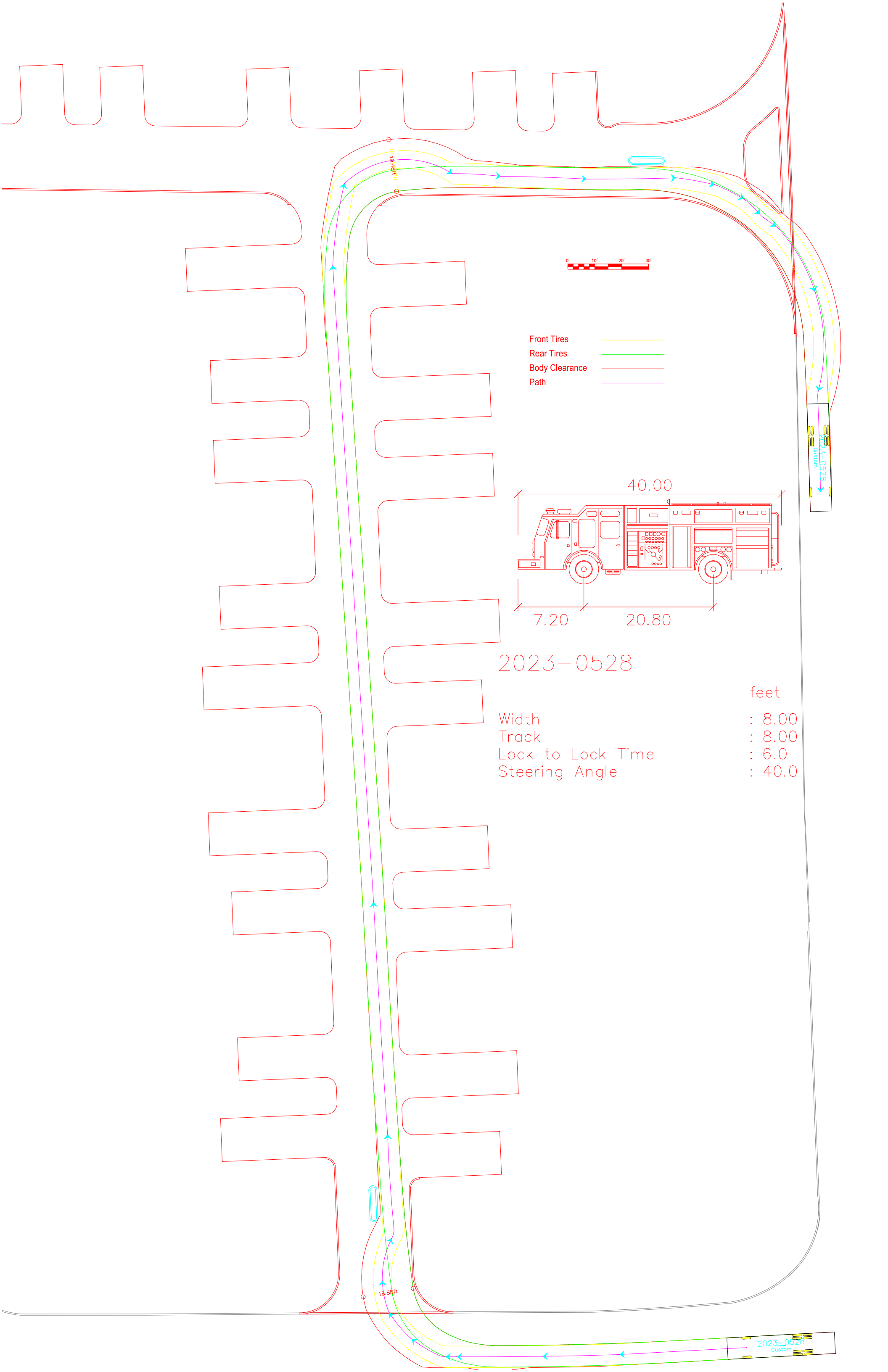

- Front Tires ———
- Rear Tires ———
- Body Clearance ———
- Path ———

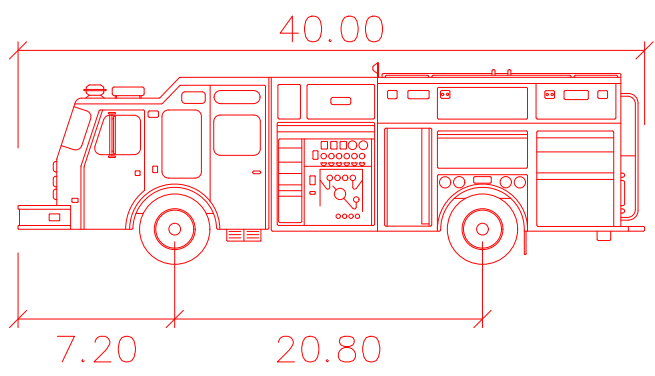

2023-0528

	feet
Width	: 8.00
Track	: 8.00
Lock to Lock Time	: 6.0
Steering Angle	: 40.0

19.44ft

18.88ft

2023-0528
Custom

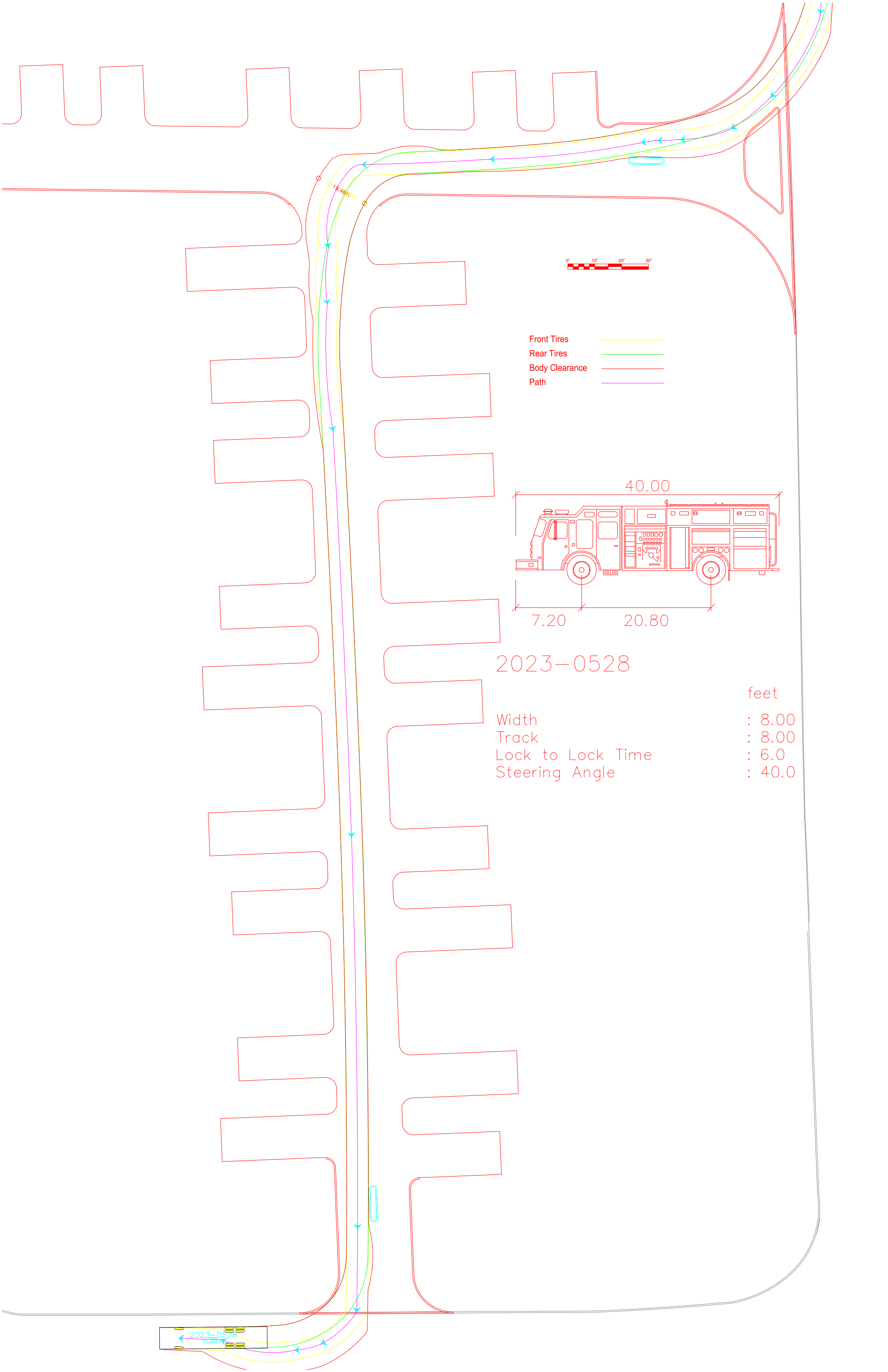

- Front Tires
- Rear Tires
- Body Clearance
- Path

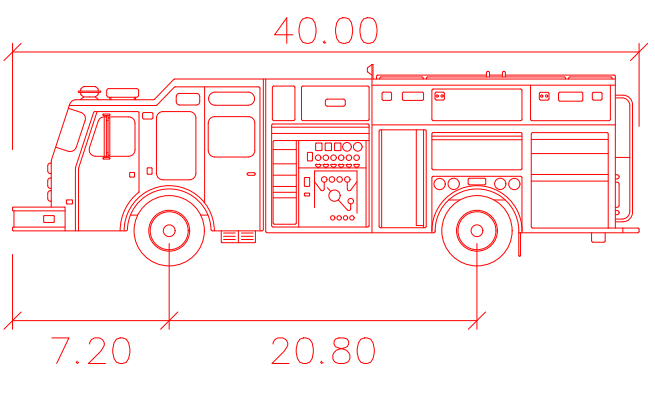

2023-0528

	feet
Width	: 8.00
Track	: 8.00
Lock to Lock Time	: 6.0
Steering Angle	: 40.0

