

VILLAGE OF LOMBARD
REQUEST FOR BOARD OF TRUSTEES ACTION
For Inclusion on Board Agenda

_____ Resolution or Ordinance (Blue) _____ Waiver of First Requested
 X Recommendations of Boards, Commissions & Committees (Green)
_____ Other Business (Pink)

TO: VILLAGE PRESIDENT AND BOARD OF TRUSTEES
FROM: Scott Niehaus, Village Manager
DATE: February 22, 2021 (B of T) **Date:** March 18, 2021
TITLE: Amendment to Village Board Policy 6.C. – Street Lighting Policy
SUBMITTED BY: Carl S. Goldsmith, Director of Public Works 

BACKGROUND/POLICY IMPLICATIONS:

The Public Works Committee has reviewed and is recommending that the Village Board Policy regarding street lighting be amended. The amendments provide clarification for maintenance of non-compliant street lights, incorporates changes to lighting standards for arterial roadway lighting, and identifies specific manufacturers and products for applications in Lombard.

FISCAL IMPACT/FUNDING SOURCE:

Review (as necessary):

Village Attorney X _____	Date _____
Finance Director X _____	Date _____
Village Manager X _____	Date _____

NOTE: All materials must be submitted to and approved by the Village Manager's Office by 12:00 noon, Wednesday, prior to the Agenda Distribution.



February 2, 2021

TO: Public Works and Environmental Concerns Committee

FROM: Carl S. Goldsmith, Director of Public Works 

SUBJECT: Amendments to Village Board Policy 6.C. - Village Standard Lighting Policy

Background

The current Village Standard Lighting Policy was reviewed by the Public Works Committee in October 2018. At that time, the Village Standard Lighting (VSL) was amended to include Light Emitting Diode (LED) as the required lighting standard for all new or replacement residential lighting and established parameters for performance and specified which fixtures and poles met the Village's standards. The Village Board approved the recommendation in December 2016.

As part of the Public Works Department's periodic review of policies and programs, additional changes are being brought forth relative to the VSL for the Committee's review and consideration. A summary of the changes can be found below and are identified in the attached redlined copy of the VSL.

- The VSL has been amended to provide language that addresses maintenance activities related to existing streetlights that are non-compliant with the policy. As poles are replaced due to damage, the VSL would have poles brought into compliance with the current standard. There are several areas, predominantly residential, where the existing lighting are 17' poles with cobra heads. By policy, these areas should have decorative flared base poles with lantern style fixtures. The Village's practice has been to replace these poles with like poles/fixtures rather than have a single pole in a neighborhood be replaced with a dissimilar style. As neighborhoods receive new lighting systems via a CIP project or special assessment program, the lights would be switched to the standard in place at the time.
- The Village has amended the specification for arterial roadways. The current standard provides for three specifications for roadway lighting; (1) decorative poles such as those found on Main Street, (2) spun aluminum poles and (3) square steel poles ("shoebox"). The proposed change to the VSL would eliminate the square steel poles. These poles are prone to rust and are significantly more expensive. The cost of the square pole is approximately \$7,500 and the cost of the spun aluminum pole is \$2,000. The Village currently has 140 shoebox lights along St. Charles Road and Westmore Road.
- The Village has identified specific manufacturers for the spun aluminum poles. Prior VSLs stated that poles would meet IDOT standards. These specifications have been added to the document.

These changes will continue the Village's move towards standardization of street lighting.

Recommendation

Staff recommends that the Public Works and Environmental Concerns Committee approve the amendments to the VSL and forward a recommendation to amend Village Standard Lighting Policy to the Village Board.



VILLAGE OF LOMBARD

VILLAGE BOARD POLICY MEMORANDUM

Subject: Street Lighting Policy

Section: 6.C.

Dept.: PW

Date: October 2, 2003

Updated: December 2, 2010

December 15, 2016

June 20, 2019

March 9, 2021

I. Purpose

This policy summarizes Village policy on street lighting in areas that do not have street lights and areas that do not have standard Village street lights. It is Village policy that all streets be lighted with Village Standard Lighting.

II. Procedures/Guidelines

A. Temporary intersection lighting

As soon as reasonably possible and within budget constraints, street lights shall be placed at all intersections utilizing ComEd lights. This is a temporary condition until permanent street lighting can be installed through the Capital Improvement Program.

B. Street reconstruction projects

Street reconstruction projects shall include street lighting. Street lighting would not be required in grind and overlay or other maintenance-type projects.

C. Stand-alone street lighting projects

Separate, stand-alone street lighting projects will be scheduled for unlit areas subject to the CIP.

D. Village Standard Lighting (VSL)

The Public Works Department will prepare a Village Standard Lighting specification that will identify lighting standards for various streets such as residential, downtown, and arterial. Changes to the pole and luminaire specification will require Village Board approval. The Director of Public Works may modify non-aesthetic specifications in the VSL at his discretion.

III. Legislation/Documentation

- A. Public Works Committee minutes of September 9, 2003
- B. Board of Trustees minutes of October 2, 2003
- C. Village Standard Lighting Specification dated December 2010
- D. Village Standard Specification dated November 2016
- E. Board of Trustees Minutes of December 15, 2016
- F. Board of Trustees Minutes of June 20, 2019



Village Standard Lighting

~~June 2019~~ March 2021

Table of Contents

	Page
Guidelines for Type of Pole and Luminaire	1
Residential Street Light Standards	3
Light Poles (Concrete Flared Base)	4
Light Poles (Concrete Straight Base)	8
Luminaire (Ornamental) LED	12
Arterial Street Light Standards	15
Light Poles (Decorative)	16
Luminaire (Decorative – Down Light) LED	18
Luminaire (Ornamental – Bracket Mounted) LED	21
Luminaire (Cobra-Head Style) LED	24
Decorative Light Standard	28
Light Poles (Spun Aluminum)	29
Light Poles (Square Steel)	30
Luminaire (Rectangular)	31
Concrete Light Pole Foundation	33
<u>T.I.F. Central Business</u> District Street Light Standards	34
<u>T.I.F. Central Business</u> District Ornamental Lighting Standard	35
Light Poles (Ornamental Steel)	
Luminaire (Ornamental T.I.F.)	
Concrete Light Pole Foundation	36
Exhibit 1	
Residential Street Light Standard Details	
Exhibit 2	
Arterial Street Light Standard Details	
Exhibit 3	
<u>T.I.F. Central Business</u> District Street Light Standard Details	

GUIDELINES FOR TYPE OF POLE AND LUMINAIRE

Policy General Statement

LED lighting is the preferred lighting source for the Village of Lombard. Other lighting applications may be reviewed on a case by case basis based upon location, cost, and other factors. The Village shall seek to use retrofit kits for lighting in an effort to be cost effective in its LED replacements. These guidelines identify approved LED luminaires; however the Village has not specified the preferred manufacturer of LED retrofit kits for each application. The Village will ensure that all retrofit kits shall meet the minimum standards set forth for each fixture application under this policy.

Residential Streets (non-collector):

~~Areas that do not have street lighting and new construction projects:~~

~~Light Pole (Concrete Flared Base) with post top Luminaire (Ornamental) LED.~~

~~Poles and/or luminaires replaced for maintenance:~~

~~Older Section of Town (Grace St., Finley Rd., Madison St., Pleasant Ave., etc.):~~

~~Light Pole replaced in kind (Flared Base) with post top Luminaire (Ornamental) and Light Pole (Spun Aluminum with mast arm) with Luminaire (Cobra Head, mast arm mounted) replaced in kind~~

~~All Other Areas:~~

~~Light Pole replaced in kind (Flared Base) with post top Luminaire (Holophane) replaced in kind~~

~~Luminaire (Ornamental) = octagonal shape~~

~~Luminaire (Holophane) = circular~~

Arterial Streets:

~~2-Lane, Residential Area:~~

~~Same as Residential Streets~~

~~4-Lane, Residential Area (including commercial neighboring residential):~~

~~Light Poles (Decorative) with Luminaire (Decorative – Down Light) and
Luminaire (Ornamental – Bracket Mounted) LED.~~

~~Commercial / Industrial Areas (no adjacent residential properties):~~

~~Light Poles (Spun Aluminum) with Luminaire (Cobra Head Type) LED.~~

~~Westmore-Meyers Road and St. Charles Rd. (Route 53 to Elizabeth and Grace
Street to Addison):~~

~~Light Poles (Square Steel) with Luminaire (bronze cobrahead), LED lighting
source.~~

~~**T.I.F. District:**~~

~~Downtown and St. Charles Road (Grace Street to Elizabeth Street)~~

~~Ornamental Lighting Standard~~

~~Light Poles (Ornamental Steel), LED light source.~~

~~Luminaire (Ornamental T.I.F.), LED light source.~~

Note:

The following sections contain specifications for the street light standards. The specifications are based on the Illinois Department of Transportation Standard Specifications for Road and Bridge Construction, current addition, as modified by the Village's Special Provisions. Only the Special Provisions are included herein; the other document is incorporated by reference. The ~~Village Engineer~~Director of Public Works has the authority to update, revise and modify the Special Provisions as deemed necessary.

The street lighting standards provide guidance for the replacement of street lights for capital projects; however, the Village recognizes that the Village's street lighting system contains assets that do not comply with the current specifications. While the

Village desires uniformity and compliance with the current street lighting standards, there are factors that must be considered to address maintenance activities.

The Village Standard Lighting shall provide specifications for the installation of new poles and luminaries in conjunction with private development and capital projects included in the Village of Lombard Capital Improvement Plan or conducted as a comprehensive street lighting project initiated by property owners. Poles and luminaires repaired or replaced in conjunction with maintenance activities conducted by the Village shall be replaced with equivalent products. The determination of equivalent products shall be made by the Director of Public Works in accordance with the specifications contained in the Village Standard Lighting.

DRAFT

**Special Provisions
for
Residential Street Light Standards**

DRAFT

SECTION 830 LIGHT POLES (CONCRETE FLARED BASE)

Rev. 01/12

830.01 Description. Add the following: These requirements cover decorative prestressed concrete poles. The poles shall be formed in a single piece, uniformly tapered with eight equal flats running lengthwise and an extension below grade for direct burial installation. They shall be prestressed, spun cast decorative concrete poles conforming to the manufacturing specifications that follow: Poles shall be designed to conform to loading requirements specified by AASHTO, The American Association of State Highway and Transportation Officials in their publication "Standard Specifications for Structural Supports for Highway Signs, Luminaires, and Traffic Signals," and conform to ASTM C-1089-97, Specifications for Spun-Cast Concrete Poles.

830.02 Materials. Add the following:

(d) Concrete Light Pole

- (1) CEMENT: Shall conform to ASTM C-150, Type III.
- (2) AGGREGATE: Shall conform to ASTM C-33 and shall be formed from natural river run materials with a maximum size of 3/8" to 5% passing the #100 sieve. This shall have a gray color.
- (3) WATER: Shall not contain quantities of alkalis, oil or organic matter that shall be harmful to the quality of the concrete.
- (4) ADMIXTURES: The use of admixtures containing calcium chloride is prohibited.
- (5) STEEL: Prestressing steel shall conform to ASTM A-421. Reinforcing bar shall conform to ASTM A-615. Wire for cage shall conform to ASTM A-82. Top mount inserts shall conform to ASTM A-304.
- (6) ALUMINUM: Aluminum for handhole frame and cover, and luminaire tenon shall be formed from aluminum conforming to ASTM B-26, alloy SG70A.
- (7) CONCRETE: Shall be formed by weighing cement and aggregates which shall be uniformly mixed with metered water, deposited in steel molds, without incurring segregation, and be compacted by centrifugal rotation along their longitudinal axis. Concrete strength at the time of transfer of prestressing shall be no less than 4000 psi., and at 28 days shall be no less than 7000 psi. by the use of spun cylinder tests. Concrete finish shall be natural exposed aggregate with gray color finish. Sample shall be submitted to the Engineer for approval prior to manufacture.

- (8) **INTERIOR CABLES:** All pole wires, including ground, shall run from the handhold to the luminaire. Interior cables shall be type 600 volt, XLP insulation, No. 10 AWG stranded copper conductors. Color coding of the pole wire shall be via solid insulation color. Neutral wires shall be white, ground wires shall be green and phase conductors shall be color coded red or black as appropriate to match the associated branch circuit conductors.

Add the following:

Equipment. The manufacturer shall provide the necessary plant, storage facilities, molds and equipment for the manufacture of lighting poles and accessories. The molds shall have sufficient rigidity to accept an initial prestress in excess of 26 tons, and such tolerances as to assure poles formed with high-resolution definition to conform to these standards.

Add the following:

Manufacturers. The concrete poles shall be Centrecon model VEM-4.6 octagonal as manufactured by Ameron, StressCrete model KS15 octagonal, or approved equivalent. For an approved substitution, the Manufacturer must demonstrate satisfactory product performance of precast, prestressed spun concrete poles in three different municipalities within the Chicagoland metropolitan area. Each pole must be available for inspection and have been in service for not less than ten years.

830.03 Installation. Add the following:

(d) Concrete Pole.

- (1) **INTERNAL STEEL:** The poles shall contain a minimum of (8) strands of 7mm diameter, solid, indented prestressing steel wires prestressed to a minimum of 6000# per wire. The indented wire shall assure that a minimum of 60% bond transfer has occurred at the narrow portion of the pole, just below the top. The pole shall not contain sections of only reinforcing bars or slack prestressing steel. A mild steel cage consisting of circumferential 12 gauge A-82 wire welded to (4) longitudinal 11 gauge wires at not more than a 4" pitch shall encapsulate the prestressing steel throughout the entire length of the pole. The area of circumferential steel along any three feet of the shaft shall not be less than design. All steel shall be electrically bonded. The cover over the prestressing wires shall be no less than 1/2".
- (2) **HANDHOLE FRAME AND COVER:** Each concrete pole shall be provided with a decorative, flush mounted, vandal resistant, 2-1/4" x 7" cast aluminum handhole frame cast integrally with the pole to assure pole strength is maintained at the handhole opening, conforming to the pole shape, 22" above groundline. This frame shall also act as a barrier to damage at the handhole

opening during transportation and installation. This opening shall be covered with a flush mounted cast aluminum handhole cover held with a minimum of (2) 1/4"-20 ss machine screws.

- (3) **TOP MOUNT TENON/INSERTS:** Each pole shall be equipped with (4) 3/8-16 threaded inserts and a cast aluminum tenon with a black finish. The tenon shall provide a secure attachment of the specified Luminaire to the top of the pole. The threaded inserts shall allow flush mounting of the removable tenon with recess for set screws. These inserts shall be cast during the forming operation and not formed by drilling the surface afterward. This will assure an aesthetically superior, low corrosion connection, and at the same time electrically bond the tenon. These inserts shall be cast with a minimum of 8" all thread bottom rods for proper concrete development.
- (4) **POLE SIZE AND SHAPE:** The pole top flare shall be 8" at the pole top and increase to 9-1/2" across the flats in 2". It shall then make a decorative 3/4" vertical step prior to flaring in to a maximum 5-1/2", 7" below the pole top. The pole then shall uniformly taper to 8-3/4", 17" above groundline, where it shall flare out to 16-3/4" across the flats. This shall step down vertically for a minimum of 1-1/4", and then step horizontally to a 20" diameter by 4" base at the groundline. The shaft shall continue at 10" diameter for 4' for the embedded portion of the pole. The overall shaft length shall be 19', with 15' above grade. Maximum pole weight shall be 1200 lbs. Pole shall be formed with two 2-1/4" x 9" cable entrances at 90 degrees and 270 degrees from the handhole, 18" below grade.
- (5) **ELECTRICAL GROUNDING:** A #8 gauge copper wire shall be accessible from the interior of the handhole which electrically bonds all of the internal steel, including the top mount inserts.
- (6) **SURFACE TREATMENT:** Following the curing of the poles, the exterior surface shall be abraded by use of a Wheelabrator process on an automatic machine to assure a uniform, sand-blasted like appearance. If an automated process is not utilized, concrete cover shall be increased to 3/4" to assure proper steel protection due to possible uneven blasting. After the abrading operation the pole shall be coated with a minimum of two coats of clear anti-graffiti, non-yellowing coating.
- (7) **INSTALLATION:** The concrete poles shall be installed to a depth of 4' below proposed, finished grade. They shall be plumb and backfilled with FA-6 placed and compacted in 9 inch lifts to a depth of 4 inches below finished grade. The pole shall be placed so that the access hole is opposite to the street-side of the pole.

- (8) **PRODUCT WARRANTY:** Products shall be covered by a warranty of no less than ten (10) years to be free of defects in materials and workmanship. The manufacturer will repair or provide a replacement of, without charge, any properly installed product that is deemed to be defective after such product has failed under normal conditions, use, service and maintenance.

~~The warranty specifically excludes the natural aging process on coatings. be warranted for a minimum of 10 years against defects in workmanship or materials. If there is a warranty defect during the first five years, an allowance of \$300 per pole shall be provided for installation and electrical re-work.~~

- (9) **REPORTING REQUIREMENTS:** If requested by the Engineer, certifications on the following shall be provided within two months of installation:
- a. Cement reports on all products.
 - b. Steel certifications on all products.
 - c. Concrete sample test data for all products.
 - d. Anti-graffiti data sheet.
 - e. Copy of Product Warranty statement.

830.05 Basis of Payment. Replace with the following: This work will be paid for at the contract unit price each for LIGHT POLE, CONCRETE, 15' MOUNTING HEIGHT, which price shall include all labor, equipment, excavation, materials including interior wiring and fusing, backfilling and compacting, and removal of spoil required to complete the work as specified herein.

~~SECTION 830 LIGHT POLES (CONCRETE STRAIGHT BASE)~~

Rev. 01/12

~~This work shall be performed in accordance with Section 830 of the Standard Specifications with the following additions:~~

~~**830.01 Description.** Add the following: These requirements cover decorative prestressed concrete poles. The poles shall be formed in a single piece, uniformly tapered with eight equal flats running lengthwise and an extension below grade for direct burial installation. They shall be prestressed, spun-cast decorative concrete poles conforming to the manufacturing specifications that follow.~~

~~Poles shall be designed to conform to loading requirements specified by AASHTO, The American Association of State Highway and Transportation Officials in their publication "Standard Specifications for Structural Supports for Highway Signs, Luminaires, and Traffic Signals," and conform to ASTM C-1089-97, Specifications for Spun-Cast Concrete Poles.~~

~~**830.02 Materials.** Add the following:~~

~~(d) Concrete Light Pole~~

~~(1) CEMENT: Shall conform to ASTM C 150, Type III.~~

~~(2) AGGREGATE: Shall conform to ASTM C 33 and shall be formed from natural river run materials with a maximum size of 3/8" to 5% passing the #100 sieve. This shall have a gray color.~~

~~(3) WATER: Shall not contain quantities of alkalis, oil or organic matter that shall be harmful to the quality of the concrete.~~

~~(4) ADMIXTURES: The use of admixtures containing calcium chloride is prohibited.~~

~~(5) STEEL: Prestressing steel shall conform to ASTM A 421. Reinforcing bar shall conform to ASTM A 615. Wire for cage shall conform to ASTM A 82. Top mount inserts shall conform to ASTM A 304.~~

~~(6) ALUMINUM: Aluminum for handhole frame and cover, and luminaire tenon shall be formed from aluminum conforming to ASTM B-26, alloy SG70A.~~

~~(7) CONCRETE: Shall be formed by weighing cement and aggregates which shall be uniformly mixed with metered water, deposited in steel molds, without incurring segregation, and be compacted by centrifugal rotation along their longitudinal axis. Concrete strength at the time of transfer of prestressing shall be no less than 4000 psi., and at 28 days shall be no less than 7000 psi. by the use of spun cylinder tests. Concrete finish shall be natural exposed aggregate with gray color~~

finish. Sample shall be submitted to the Engineer for approval prior to manufacture.

- (8) ~~INTERIOR CABLES:~~ All pole wires, including ground, shall run from the handhold to the luminaire. Interior cables shall be type 600 volt, XLP insulation, No. 10 AWG stranded copper conductors. Color coding of the pole wire shall be via solid insulation color. Neutral wires shall be white, ground wires shall be green and phase conductors shall be color coded red or black as appropriate to match the associated branch circuit conductors.

Add the following:

Equipment. The manufacturer shall provide the necessary plant, storage facilities, molds and equipment for the manufacture of lighting poles and accessories. The molds shall have sufficient rigidity to accept an initial prestress in excess of 26 tons, and such tolerances as to assure poles formed with high-resolution definition, to conform to these standards.

Add the following:

Manufacturers. The concrete poles shall be Centrecon model SEO 4.3 octagonal as manufactured by Ameron, StressCrete model E-180 APO-G E40 octagonal, or approved equivalent. Manufacturer must demonstrate satisfactory product performance of precast, prestressed spun concrete poles in three different municipalities within the Chicago metropolitan area. Each pole must be available for inspection and have been in service for not less than ten years.

830.04 Installation. Add the following:

(d) ~~Concrete Pole.~~

- (1) ~~INTERNAL STEEL:~~ The poles shall contain a minimum of (8) strands of 5mm diameter, solid, indented prestressing steel wires prestressed to a minimum of 6000# per wire. The indented wire shall assure that a minimum of 60% bond transfer has occurred at the narrow portion of the pole, just below the top. The pole shall not contain sections of only reinforcing bars or slack prestressing steel. A mild steel cage consisting of circumferential 13 gauge A-82 wire welded to (4) longitudinal 11 gauge wires at not more than a 4" pitch shall encapsulate the prestressing steel throughout the entire length of the pole. The area of circumferential steel along any three feet of the shaft shall not be less than design. All steel shall be electrically bonded. The cover over the prestressing wires shall be no less than 3/8".

- (2) ~~HANDHOLE FRAME AND COVER:~~ Each concrete pole shall be provided with a decorative, flush mounted, vandal resistant, 1-5/8" x 9" cast aluminum handhole frame cast integrally with the pole to assure pole strength is

~~maintained at the handhole opening, conforming to the pole shape, 18" above groundline. This frame shall also act as a barrier to damage at the handhole opening during transportation and installation. This opening shall be covered with a flush mounted cast aluminum handhole cover held with a minimum of (2) 1/4" 20 ss machine screws.~~

- ~~(3) TOP MOUNT TENON/INSERTS: Each pole shall be equipped with (2) 5/16-16 threaded inserts and a cast aluminum tenon with a black finish. The tenon shall provide a secure attachment of the specified Luminaire to the top of the pole. The threaded inserts shall allow mounting of the removable tenon with recess for set screws. These inserts shall be cast during the forming operation and not formed by drilling the surface afterward. This will assure an aesthetically superior, low corrosion connection, and at the same time electrically bond the tenon. These inserts shall be cast with a minimum of 8" all thread bottom rods for proper concrete development.~~
- ~~(4) POLE SIZE AND SHAPE: The pole top shall be 3 1/2". It shall then uniformly taper to the base diameter of 6 2/8". The overall shaft length shall be 18' 1", with 14' 1" above grade. Maximum pole weight shall be 500 lbs. Pole shall be formed with two 5/8" x 8" cable entrances at 90 degrees and 270 degrees from the handhole, 18" below grade.~~
- ~~(5) ELECTRICAL GROUNDING: A #8 gauge copper wire shall be accessible from the interior of the handhole which electrically bonds all of the internal steel, including the top mount inserts.~~
- ~~(6) SURFACE TREATMENT: Following the curing of the poles, the exterior surface shall be abraded by use of a Wheelabrator process on an automatic machine to assure a uniform, sand blasted like appearance. If an automated process is not utilized, concrete cover shall be increased to 1/2" to assure proper steel protection due to possible uneven blasting. After the abrading operation the pole shall be coated with a minimum of two coats of clear anti-graffiti, non yellowing coating.~~
- ~~(7) INSTALLATION: The concrete poles shall be installed to a depth of 4' below proposed, finished grade. They shall be plumb and backfilled with FA-6 placed and compacted in 9 inch lifts to a depth of 4 inches below finished grade. The pole shall be placed so that the access hole is opposite to the street side of the pole.~~
- ~~(8) PRODUCT WARRANTY: Products shall be warranted for a minimum of 10 years against defects in workmanship or materials. If there is a warranty defect during the first five years, an allowance of \$300 per pole shall be provided for installation and electrical re-work.~~

~~(9) — REPORTING REQUIREMENTS: If requested by the Engineer, certifications on the following shall be provided within two months of installation:~~

- ~~a. — Cement reports on all products.~~
- ~~b. — Steel certifications on all products.~~
- ~~c. — Concrete sample test data for all products.~~
- ~~d. — Anti-graffiti data sheet.~~
- ~~e. — Copy of Product Warranty statement.~~

~~**830.05 Basis of Payment.** Replace the section with the following: This work will be paid for at the contract unit price each for **LIGHT POLE, CONCRETE, 14'-1" MOUNTING HEIGHT**, which price shall include all labor, equipment, excavation, materials including interior wiring and fusing, backfilling and compacting, and removal of spoil required to complete the work as specified herein.~~

DRAFT

SECTION 1067 ROADWAY LUMINAIRES (ORNAMENTAL) LED

REV. 12/10

This work shall consist of furnishing and installing luminaires on street light standards in accordance with Sections 1065, 1066, and 1067 of the Standard Specifications with the following alterations.

Replace section **1067.01 General**. with

- (a) **Driver.** The LED driver shall be securely mounted inside the fitter, for optimized performance and longevity. The LED driver shall be supplied with a quick-disconnect electrical connector on the power supply, providing easy power connections and fixture installation.
- (b) **Light Sources.** The luminaire shall use high output, high brightness LEDs. The LEDs shall be mounted in arrays, on printed circuit boards designed to maximize heat transfer to the heat sink surface. The LEDs shall be attached to the printed circuit board with not less than 90% pure silver to insure optimal electrical and thermal conductivity. The LEDs and printed circuit boards shall be protected from moisture and corrosion by a conformal coating of 1 to 3 mils. The LEDs are printed circuit board construction shall be environmentally friendly and 100 % recyclable. They shall not contain lead, mercury or any other hazardous substances and shall be RoHS complaint. The LED like rating data shall be determined in accordance with IESNA LM-80-08.
- (c) **Optics.** The luminaire shall be provided with individual, acrylic, refractor type optics applied to each LED. The luminaire shall provide Type III or type V light distribution per the IESNA classifications, based upon application of the luminaire. Testing shall be done in accordance with IESNA LM-79-08.
- (d) **Performance.** The LED arrays shall be built in series-parallel circuits which maintain overall light output in the event of single LED failures. The LEDs and LED driver shall operate over a -40°C (-40°F) to 50°C (122°F) ambient air temperature range. The high performance white LEDs shall have a life expectancy of approximately 70,000 hours with not less than 70% of original brightness (lumen maintenance), rated at 25°C. The High Brightness, High Output LEDs shall be a minimum of 3000K color temperature with a minimum of 75 CRI.
- (e) **Electronic Drivers.** The driver shall be UL Listed or Recognized. The driver shall have overload as well as short circuit protection. The driver shall pass the IEC6100-4-5 lightning test and isolate the LED's from power line transients. The driver shall be a DC voltage output, constant current design, 50/60 HZ.
- (f) **A House Side Shield (HSS)** that will block up to 120° of light in any one direction shall be included with the Luminaire and shall be installed by the contractor at the

Village's direction after the initial one-week burn-in period.

- (g) **Finish.** Prior to coating, each luminaire shall be chemically cleaned & etched or sandblasted to create a uniform surface texture and to ensure superior bonding. The washing system shall include alkaline cleaning, rinsing, phosphoric etching, reverse osmosis water rinsing, and non-chrome sealing to ensure corrosion resistance and excellent adhesion for the finish coating. The finish coating shall be electrostatically applied semigloss, super durable polyester powder.

Add the following:

Materials. Materials shall meet the requirements of Sections 1065, 1066, and 1067 and the following.

- (a) **FITTER:** The fitter shall be heavy wall cast aluminum, 319 alloy for high tensile strength. It shall have an inside diameter opening to attach to a 7" tenon. The fitter shall be secured to the pole tenon by three stainless steel, serrated cone point tamper-resistant set screws.
- (b) **ELECTRICAL:** The fixture shall be U.L. listed and wired for the system operating voltage.
- (c) **INTERIOR CABLES:** All pole wires, including ground, shall run from the handhold to the luminaire. Interior cables shall be type 600 volt, XLP insulation, No. 10 AWG stranded copper conductors. Color coding of the pole wire shall be via solid insulation color. Neutral wires shall be white, ground wires shall be green and phase conductors shall be color coded red or black.
- (d) **FIXTURE HOUSING:** The fixture shall be 15-1/2" wide and 38" tall. It shall be made of heavy wall cast aluminum, 319 alloy for high tensile strength. The lens panels shall be vandal resistant, prismatic acrylic. The fixture shall have a solid roof and a cast aluminum 6 1/2" decorative spiked finial. Fixtures shall include a 2 inch wide glare shield manufactured into the top edge of the lens panels.

Manufacturers. The luminaire shall be Sternberg model MS805BLED to SF 7" O.D. TENON/ARC30T3/PA/BK, Lumec model (L70-001)-90W49LED3K-GL-FC-LE3-120-SF7TN-BKTX, King K56 Cleveland or approved equivalent. Manufacturer must demonstrate satisfactory product performance of cast aluminum, post top mount, octagonal luminaires in three different municipalities within the Chicago metropolitan area. Each luminaire must be available for inspection and have been in service for not less than three years.

Add the following:

Basis of Payment. This work will be paid for at the contract unit price each for LUMINAIRE (ORNAMENTAL), LED which price shall include all labor, equipment, and materials to

complete the work as specified herein. Street light standards will be paid for separately, as specified elsewhere in these special provisions.

DRAFT

**Special Provisions
for
Arterial Street Light Standards**

DRAFT

SECTION 830 LIGHT POLES (DECORATIVE)

Rev. 02/10

This work shall be performed in accordance with Section 830 and 1069 of the Standard Specifications with the following additions.

830.02 Materials. Add the following: All pole wires, including ground, shall run from the handhold to the luminaire. Interior cables shall be type 600 volt, XLP insulation, No. 10 AWG stranded copper conductors. Color coding of the pole wire shall be via solid insulation color. Neutral wires shall be white, ground wires shall be green and phase conductors shall be color coded red or black as appropriate to match the associated branch circuit conductors.

The 30-foot steel decorative pole shall be one-piece construction. The pole shall be 11 gauge steel with a minimum of 8.5" in diameter at the bottom tapering to a minimum of 4.3" at the top. A 319 alloy cast aluminum, decorative two-piece split base cover shall clamp around the base plate and lower shaft of the pole assembly. The base cover shall have a 24" diameter with a height of 45". It shall be clamped together using six tamper-proof stainless steel screws. The base cover shall be a Sternberg 9201-SS Oxford. An access door shall be provided in the pole shaft and in the cast aluminum base cover for wiring and shall be mechanically secured with two stainless steel screws. The pole base cover shall be designed with long curved flutes which slope to a decorative ring. The round tapered smooth pole shaft shall be made of 11 gauge steel. The pole shall have a Sternberg RPBP post center cap and Sternberg 8' DAG roadway arm made of steel with a cast aluminum decorative scroll. The arm shall be bolted to a post mount flange, which shall be welded to the pole to ensure proper alignment to the base. Arms shall be pre-wired for ease of installation. The arm shall have a fitter that will accommodate the Sternberg 1914 Libertyville or the Sternberg 1914ALED Libertyville or Hadco Teardrop TF6 down light luminaire. A Sternberg 579PM bracket shall be mounted on the pole with a fitter that will accommodate a pole mounted Sternberg model MS805B luminaire or Sternberg model MS805B/4ARCC30T3 LED luminaire. The light standard including the pole, base cover, roadway arm, banner arms, pole mounted bracket, and post center cap shall have a bronze finish. The Contractor shall submit color samples for approval by the Village. The finish shall be a thermoset polyester powdercoat applied by the manufacturer.

Festoon receptacle outlets shall be a duplex receptacle on a separate circuit, 15 ampere, 120 volt, with a weatherproof cover mounted at 22' above the ground. The receptacle shall be wired to a GFCI reset (Hubbell Catalog No. GFHW13015) located at the base of the pole. The GFCI reset shall be easily accessible from the handhole.

Two banner arms shall be mounted in the same direction as the bracket mounted luminaire at 20' and 26' above the ground to accommodate a 32" by 72" banner.

A flag holder shall be mounted 180 degrees from the bracket mounted luminaire at 14' above the ground.

Add the following:

Manufacturers. Light poles shall be 9230SRT8.5 with a 9201-SS Oxford base cover manufactured by Sternberg. Manufacturer must demonstrate satisfactory product performance of steel roadway poles in three different municipalities within the Chicago metropolitan area. Each pole must be available for inspection and have been in service for not less than three years.

830.03 Installation. Add the following to subsection (a): The pole shall be placed so that the access hole is opposite to the street-side of the pole.

830.04

Basis of Payment. Replace the section with the following: This work will not be paid for separately, but shall be included in the cost of the item DECORATIVE LIGHT STANDARD as specified elsewhere in these special provisions.

DESIGN ENGINEER SHALL INCLUDE THE FOLLOWING ON THE DRAWINGS:

- **POLE TYPE**
- **BASE COVER**
- **POST TOP FINIAL**
- **ARM**
- **BRACKET**
- **POST MOUNT LUMINAIRE**
- **DOWN LIGHT LUMINAIRE**
- **BANNER ARMS**
- **FLAG POLE HOLDER**
- **FESTOON OUTLET**

THE DESIGN ENGINEER SHALL ALSO STATE THE BASIS OF THE LIGHTING DESIGN (MANUFACTURER, MODEL, ETC.) ON THE PLANS WITH A NOTE REQUIRING SUBMITTAL OF PHOTOMETRIC CALCULATIONS IF THE CONTRACTOR USES ANOTHER PRODUCT.]

SECTION 1067 LUMINAIRE (DECORATIVE – DOWN LIGHT) LED

REV. 02/10

This work shall consist of furnishing and installing luminaires on street light standards in accordance with Sections 1065, 1066, and 1067 of the Standard Specifications with the following alterations.

Replace section **1067.01 General**. with

- (a) **Driver.** The LED driver shall be securely mounted inside the fitter, for optimized performance and longevity. The LED driver shall be supplied with a quick-disconnect electrical connector on the power supply, providing easy power connections and fixture installation.
- (b) **Light Sources.** The luminaire shall use high output, high brightness LEDs. The LEDs shall be mounted in arrays, on printed circuit boards designed to maximize heat transfer to the heat sink surface. The LEDs shall be attached to the printed circuit board with not less than 90% pure silver to insure optimal electrical and thermal conductivity. The LEDs and printed circuit boards shall be protected from moisture and corrosion by a conformal coating of 1 to 3 mils. The LEDs are printed circuit board construction shall be environmentally friendly and 100 % recyclable. They shall not contain lead, mercury or any other hazardous substances and shall be RoHS complaint. The LED like rating data shall be determined in accordance with IESNA LM-80-08.
- (c) **Optics.** The luminaire shall be provided with individual, acrylic, refractor type optics applied to each LED. The luminaire shall provide Type III or Type V, based upon application of the luminaire, light distribution per the IESNA classifications. Testing shall be done in accordance with IESNA LM-79-08. The fixture shall have a 2" wide glare shield applied to the upper portion of the inside of the tear drop lens.
- (d) **Performance.** The LED arrays shall be built in series-parallel circuits which maintain overall light output in the event of single LED failures. The LEDs and LED driver shall operate over a -40°C (-40°F) to 50°C (122°F) ambient air temperature range. The high performance white LEDs shall have a life expectancy of approximately 70,000 hours with not less than 70% of original brightness (lumen maintenance), rated at 25°C. The High Brightness, High Output LEDs shall be a minimum of 3000K color temperature with a minimum of 75 CRI.
- (e) **Electronic Drivers.** The driver shall be UL Listed or Recognized. The driver shall have overload as well as short circuit protection. The driver shall pass the IEC6100-4-5 lightning test and isolate the LED's from power line transients. The driver shall be a DC voltage output, constant current design, 50/60 HZ.
- (f) **Finish.** Prior to coating, each luminaire shall be chemically cleaned & etched or

sandblasted to create a uniform surface texture and to ensure superior bonding. The washing system shall include alkaline cleaning, rinsing, phosphoric etching, reverse osmosis water rinsing, and non-chrome sealing to ensure corrosion resistance and excellent adhesion for the finish coating. The finish coating shall be electrostatically applied semigloss, super durable polyester powder.

Add the following:

Materials. Materials shall meet the requirements of Sections 1065, 1066, and 1067 and the following.

- (a) **FITTER:** The fitter shall be heavy wall cast aluminum, 319 alloy for high tensile strength. It shall have a fitter that connects to a Sternberg DAG 8' arm.
- (b) **ELECTRICAL:** The fixture shall be U.L. listed. The luminaire shall be wired for 240 volt operation.
- (c) **INTERIOR CABLES:** All pole wires, including ground, shall run from the handhold to the luminaire. Interior cables shall be type 600 volt, XLP insulation, No. 10 AWG stranded copper conductors. Color coding of the pole wire shall be via solid insulation color. Neutral wires shall be white, ground wires shall be green and phase conductors shall be color coded red or black.
- (d) **FIXTURE HOUSING:** The fixture diameter shall be a minimum of 16 1/2" to a maximum of 18 5/8". The fixture height shall be a minimum of 30 3/4" to a maximum of 32" tall. Its dome housing shall be made of cast aluminum having 4 each wide band vertical ribs matching the ribs in its mid section and terminated with a large diameter round hinged cap fitter. Fixtures shall include a 2 inch wide glare shield manufactured into the top edge of the lens panels.

Add the following:

Manufacturers. The luminaire shall be Sternberg 1914 Libertyville Series 1914ALED/5A1R30T3/DAG8 or Stresscrete K804 Coronet SR Deep Dish. Manufacturer must demonstrate satisfactory product performance of cast aluminum, arm mounted luminaires in three different municipalities within the Chicago metropolitan area. Each luminaire must be available for inspection and have been in service for not less than three years.

Add the following:

Construction Requirements. Products shall be warranted for a minimum of three years against defects in workmanship or materials.

Add the following:

Basis of Payment. This work will not be paid for separately, but shall be included in the cost of the item DECORATIVE LED LIGHT STANDARD as specified elsewhere in these special provisions.

DRAFT

SECTION 1067 LUMINAIRE (ORNAMENTAL – BRACKET MOUNTED) LED

REV. 03/10

This work shall consist of furnishing and installing luminaires on street light standards in accordance with Sections 1065, 1066, and 1067 of the Standard Specifications with the following alterations.

Replace section **1067.01 General**. with

- (h) **Driver.** The LED driver shall be securely mounted inside the fitter, for optimized performance and longevity. The LED driver shall be supplied with a quick-disconnect electrical connector on the power supply, providing easy power connections and fixture installation.
- (i) **Light Sources.** The luminaire shall use high output, high brightness LEDs. The LEDs shall be mounted in arrays, on printed circuit boards designed to maximize heat transfer to the heat sink surface. The LEDs shall be attached to the printed circuit board with not less than 90% pure silver to insure optimal electrical and thermal conductivity. The LEDs and printed circuit boards shall be protected from moisture and corrosion by a conformal coating of 1 to 3 mils. The LEDs are printed circuit board construction shall be environmentally friendly and 100 % recyclable. They shall not contain lead, mercury or any other hazardous substances and shall be RoHS complaint. The LED like rating data shall be determined in accordance with IESNA LM-80-08.
- (j) **Optics.** The luminaire shall be provided with individual, acrylic, refractor type optics applied to each LED. The luminaire shall provide Type III or Type V, based upon application of the luminaire, light distribution per the IESNA classifications. Testing shall be done in accordance with IESNA LM-79-08.
- (k) **Performance.** The LED arrays shall be built in series-parallel circuits which maintain overall light output in the event of single LED failures. The LEDs and LED driver shall operate over a -40°C (-40°F) to 50°C (122°F) ambient air temperature range. The high performance white LEDs shall have a life expectancy of approximately 70,000 hours with not less than 70% of original brightness (lumen maintenance), rated at 25°C. The High Brightness, High Output LEDs shall be a minimum of 3000K color temperature with a minimum of 75 CRI.
- (l) **Electronic Drivers.** The driver shall be UL Listed or Recognized. The driver shall have overload as well as short circuit protection. The driver shall pass the IEC6100-4-5 lightning test and isolate the LED's from power line transients. The driver shall be a DC voltage output, constant current design, 50/60 HZ.
- (m) **A House Side Shield (HSS)** that will block up to 120° of light in any one direction shall be included with the Luminaire and shall be installed by the contractor at the

Village's direction after the initial one-week burn-in period.

- (n) **Finish.** Prior to coating, each luminaire shall be chemically cleaned & etched or sandblasted to create a uniform surface texture and to ensure superior bonding. The washing system shall include alkaline cleaning, rinsing, phosphoric etching, reverse osmosis water rinsing, and non-chrome sealing to ensure corrosion resistance and excellent adhesion for the finish coating. The finish coating shall be electrostatically applied semigloss, super durable polyester powder.

Add the following:

Materials. Materials shall meet the requirements of Sections 1065, 1066, and 1067 and the following.

- (a) **FITTER:** The fitter shall be heavy wall cast aluminum, 319 alloy for high tensile strength. It shall have an opening to attach to a Sternberg 579PM bracket. The fitter shall be secured to the post mounted bracket by three stainless steel, serrated cone point tamper-resistant set screws.
- (b) **ELECTRICAL:** The fixture shall be U.L. listed. The luminaire shall be wired for 240 volt operation.
- (c) **INTERIOR CABLES:** All pole wires, including ground, shall run from the handhold to the luminaire. Interior cables shall be type 600 volt, XLP insulation, No. 10 AWG stranded copper conductors. Color coding of the pole wire shall be via solid insulation color. Neutral wires shall be white, ground wires shall be green and phase conductors shall be color coded red or black.
- (d) **FIXTURE HOUSING:** The fixture shall be 15-1/2" wide and 38" tall. It shall be made of heavy wall cast aluminum, 319 alloy for high tensile strength. The lens panels shall be vandal resistant, prismatic acrylic. The fixture shall have a solid roof and a cast aluminum 6 1/2" decorative spiked finial. Fixtures shall include a 2 inch wide glare shield manufactured into the top edge of the lens panels.

Add the following:

Manufacturers. The luminaire shall be Sternberg model MS805B/4ARC30T3/FHC/579PM, Lumec model (L70-001)-90W49LED3K-GL-FC-LE3-120-SF7TN-BKTX, King K56 Cleveland or approved equivalent. Manufacturer must demonstrate satisfactory product performance of cast aluminum, post top mount, octagonal luminaires in three different municipalities within the Chicago metropolitan area. Each luminaire must be available for inspection and have been in service for not less than three years.

Add the following:

Construction Requirements. Products shall be warranted for a minimum of three years against defects in workmanship or materials.

Add the following:

Basis of Payment. This work will not be paid for separately, but shall be included in the cost of the item DECORATIVE LED LIGHT STANDARD as specified elsewhere in these special provisions.

DRAFT

SECTION 1067 ROADWAY LUMINAIRE (COBRA-HEAD TYPE) LED

REV. 10/13

This work shall consist of furnishing and installing luminaires on street light standards in accordance with Sections 1065, 1066, and 1067 of the Standard Specifications with the following alterations.

Add the following Article to Section 1067:

1067.09 Light Emitting Diode (LED) Luminaires. LED Luminaires shall be according to the following.

- (o) General. LED luminaires shall be installed in accordance with Section 821 of the Illinois Department of Transportation Standard Specifications for Road and Bridge Construction Adopted January 1, 2012 except as herein modified.
- (p) LED Roadway Luminaire. The luminaire shall be optically sealed, mechanically strong and easy to maintain. The luminaire shall be designed as to its size, shape and weight so it does not aggravate the vibration characteristics of its respective pole and it shall be compatible with Village Standard poles and mast arms. The luminaire shall be vibration tested and pass ANSI C136.31 requirements. The luminaire shall be rated “3G” minimum peak acceleration. The luminaire shall have an effective projected area of 1.4 square feet or less and shall weigh not more than 50 pounds.

The luminaire shall have a full cutoff classification as defined in the “American National Standard Practice for Roadway Lighting”, ANSI-IES RP-8.

- (1) Housing. The luminaire shall be gasketed and sealed, and shall be UL or CSA (US) listed for wet locations. The luminaire optical assembly shall have a minimum IEC ingress penetration rating of IP 65. When furnished with a lens and frame, the lens shall be made of crystal clear, impact and heat resistant flat glass. The lens and frame shall be securely attached to the main housing and be readily removable for servicing the LED optical assembly. The drivers shall be mounted in the rear of the luminaire on the inside of a hinged removable door or on a removable mounting pad. The removable door or pad shall be secure when fastened in place and all individual components shall be secure upon the removable element. Each component shall be readily removable from the removable element for replacement. The luminaire mounting shall slip fit on a mast arm with a 2” tenon (2.375” outer diameter), and shall have a barrier to limit the amount of insertion. A tenon guard shall be provided to protect against birds and similar intruders. The luminaire shall be provided with a leveling surface and shall be capable of being tilted by ± 5 degrees and rotated to any degree with respect to the supporting arm. The housing shall be designed for natural removal of dirt and debris and to ensure maximum heat transfer and long LED life.

- (2) Hardware. All hardware shall be stainless steel or other high-strength corrosion resistant material of heavy duty construction. All hardware shall be captive, not susceptible to falling from the luminaire during maintenance operations.
- (3) Electrical. The luminaire shall be suitable for operation at 120, 240 or 480 volts as specified in the plan documents. Terminal blocks shall be provided for incoming 10 gauge power wiring. Electronic LED drives shall be provided for each luminaire. Each electronic driver shall have a power factor of greater than 90% and total harmonic distortion of less than 20%. The input wattage of the luminaire shall not exceed 218 watts. The electronic drivers shall be installed in a manner to keep them mechanically and thermally separated for the LED array heat sink. Integral surge protection shall be provided for each luminaire. Surge protection shall be tested in accordance with ANSI/IEEE C62.45 per ANSI/IEEE C62.41.2 Scenario 1 Category C High Exposure 10kV/10kA waveforms. The luminaire shall be furnished with a 5-pin dimming NEMA twistlock photo control receptacle and shorting cap.
- (4) LED Optical Assembly. The LED optical assembly shall be a structured array optimized for roadway photometric distribution. It shall utilize high brightness, long life 70 CRI, 4,000K ($\pm 10\%$) LEDs. Lumen depreciation at 50,000 hours shall not exceed 90% of initial.
- (5) Finish. The luminaire finish shall be electrostatically applied thermoset powdercoat that has been tested for superior weatherability and fade resistance in accordance with ANSI B117 specifications. The color of the luminaire shall be silver or gray.
- (6) Manufacturing. The luminaire shall be compliant with the Buy American provision set forth by the American Recovery and Reinvestment Act of 2009 (ARRA).
- (q) Manufacturers. The following manufacturers with their corresponding model are the only approved fixtures for the Village and are pre-approved for Illinois Tollway Authority use. No other manufacturers or models are acceptable without prior approval of the Village.

Manufacturer	Model
American Electric	Autobahn ATBL
Cooper Lighting	Navion
General Electric	Evolve LED

- (r) Photometric Performance Requirements. If specific order numbers are not provided

in the plan documents, photometric calculations will be required to be provided to meet the requirements set in the contract documents.

For 250 watt high pressure sodium replacement the following fixtures shall be supplied:

Manufacturer	Model	Catalog Number
American Electric	Autobahn	ATB2 60B LED E10 R3
Cooper Lighting	Navion	NVN-AA-04-E-U-SL2
General Electric	Evolve	ERL1007C340DGRAYGLR

(s) Preparation for Delivery. Luminaires shall be packaged in accordance with the standard commercial practices in the industry. Each shipping container shall be clearly marked to indicate contents, the manufacturer, date of manufacture, make, model, electrical ratings, purchase order number, and Contract Number.

(t) Manufacturer's Warranty. The manufacturer shall warrant to the Village that each complete luminaire (consisting of the housing, optical assembly, LED drivers, surge protection and wiring) will be free from defects in material and workmanship for five (5) years from the date that the luminaires are put into service. Luminaires shall be installed within one year of manufacture.

If any luminaires fail to meet the above warranty, the Village shall provide the manufacturer with a written notice of any defect within thirty (30) days after discovery of the defect. The manufacturer shall provide all materials, luminaires, replacement component parts, labor and all incidentals necessary to restore the luminaire to a fully operational, installed condition.

(u) Submittal Requirements. Within 30 calendar days after contract execution, the Contractor shall submit, for approval, five copies each of the following manufacturer's product data for each type of luminaire.

- (1) Descriptive literature and luminaire catalog cuts
- (2) Computer calculations based on the performance tables
- (3) Luminaire I.E.S. distribution classification
- (4) LED Driver catalog cut
- (5) Surge Protector catalog cut
- (6) Isofootcandle chart with max candela point and half candela trace indicated
- (7) Isocandela diagram
- (8) Number of LEDs
- (9) Initial delivered lumens

- (10) Lumen depreciation at 25,000 hours
- (11) Lumen depreciation at 50,000 hours
- (12) L70 hours at 25 degrees C
- (13) System watts at design volts
- (14) Total current at design volts
- (15) I.E.S. files on a disc

DRAFT

DECORATIVE LIGHT STANDARD

Rev. 12/10

This work shall be performed in accordance with Sections 830, 1065, 1066, 1067, and 1069 of the Standard Specifications with the following additions.

Add the following:

Manufacturers. Light Pole (Decorative) and Luminaire (Decorative – Down Light) shall be by the same manufacturer. Luminaire (Ornamental – Bracket Mounted) may be by any of the three manufacturers identified in these special provisions.

Basis of Payment. This work will be paid for at the contract unit price per each for DECORATIVE LIGHT STANDARD or DECORATIVE LED LIGHT STANDARD which price shall include Light Pole (Decorative), Luminaire (Decorative – Down Light) and Luminaire (Ornamental – Bracket Mounted). The price shall include all labor, equipment, materials, including interior wiring and fusing, required to complete the work as specified in these special provisions.

DRAFT

LIGHT POLES (SPUN ALUMINUM)

IDOT Standard Item

Use IDOT's standard pay item for LIGHT POLE with no modifications as described in Section 830. Light Poles of the IDOT Standard Specifications for Road and Bridge Construction.

Add the following:

Manufacturers. Light poles shall be Hapco Series 20 Poles W/Tapered Elliptical Arms-catalog #21-587 – 30' mounting height or Hapco Series 30 poles W/Truss Arms- catalog #31-565-30' mounting height. Manufacturer must demonstrate satisfactory product performance of steel roadway poles in three different municipalities within the Chicago metropolitan area. Each pole must be available for inspection and have been in service for not less than three years.

DRAFT

LIGHT POLES (SQUARE STEEL)

Rev. 08/04

Description. ~~This work shall consist of furnishing and installing square tapered light poles complete with bracket arm and all required hardware including bolt covers.~~

Material. ~~The thirty five foot light pole shall be a 7 gauge square tapered shaft (nominally 8" x 4") formed from a single steel sheet. The bracket arm shall be square tapered (nominally 4" x 3 3/8"), 6' long and have a 2" round slip fitter attachment. Poles shall have a 4" x 6" handhole with vandal resistant cover and shall be provided with a square base cover. Poles shall have a duplex receptacle with weatherproof enclosure. 4 1/2" x 3/8" hot dipped galvanized anchor bolts shall be furnished with each pole. The bolt circle shall be 13 1/2" or as recommended by the pole manufacturer. Poles and bracket arms shall have a dark bronze powder coated finish.~~

~~Fasteners and hardware shall be in accordance with the requirements of Section 1088.03 of the Standard Specifications.~~

Manufacturers. ~~The light pole shall be manufactured by Valmont or approved equivalent.~~

Installation. ~~The light pole shall be installed in accordance with the requirements of Section 830 of the Standard Specifications.~~

Basis of Payment. ~~This item shall be paid for at the contract unit price each for LIGHT POLE, STEEL, SQUARE TAPERED, 35 FT. M.H, 6 FT. MAST ARM.~~

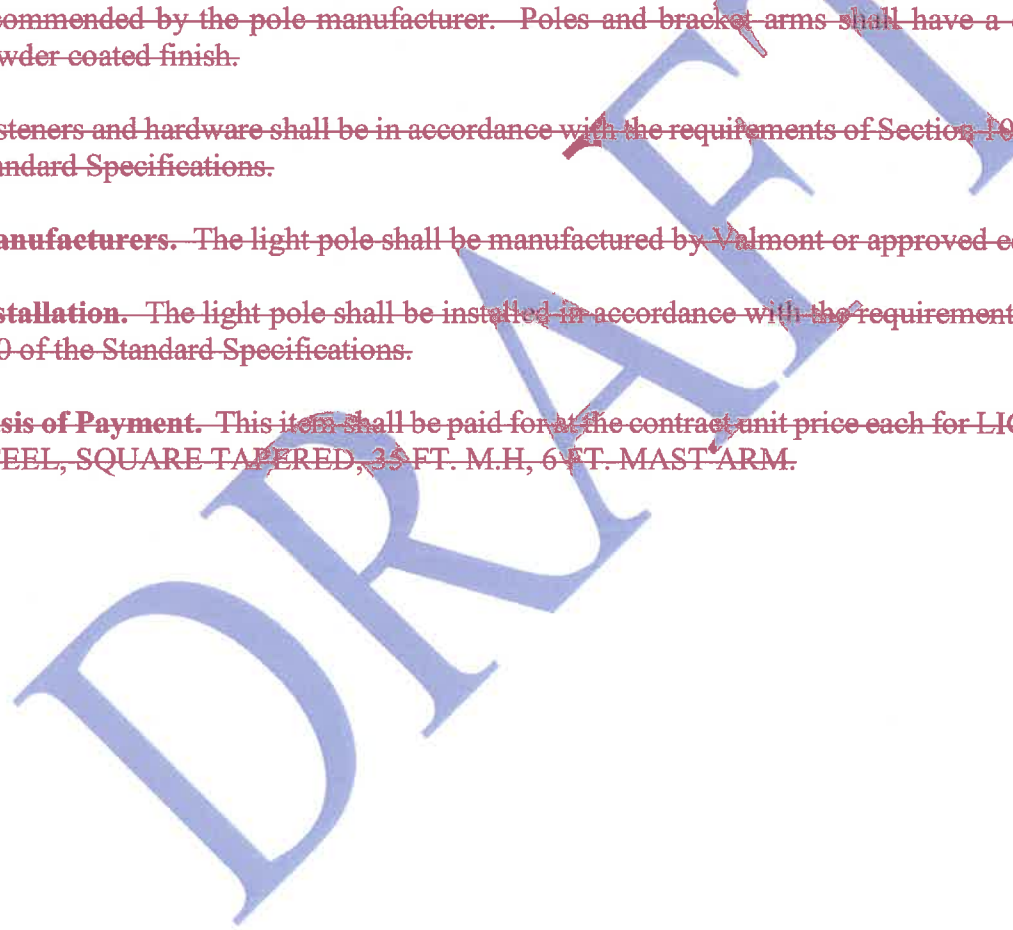

LUMINAIRE (RECTANGULAR)

Rev. 09/04

Description. This work shall consist of furnishing and installing a luminaire including branch circuit/extension pole wire as applicable, lamp, fuseholders, mounting hardware and fusing.

Material. Each luminaire shall be rectangular in shape and constructed of heavy gauge welded aluminum shaped from one piece of aluminum. The lens door shall be welded extruded aluminum. Welds shall be ground smooth. The luminaire shall have a ballast compartment that is isolated from the lamp section. Access to the ballast section shall be through a hinged door cover. Each luminaire shall be supplied with a reflector, adjustable lamp socket and flat clear tempered glass lens. Integral ballast shall be multi tap magnetic regulation type wired for 240 volt operation. Ballast components, core and coil, capacitors and starting aid shall be mounted on a main support brace. Each luminaire shall be equipped with a welded aluminum slip fitter for mounting to a pole tenon. Fitter shall accommodate a 2" (2.375" O.D.) pipe and shall have a 3-degree leveling adjustment. Each luminaire shall have a dark bronze powder coated finish. Luminaires shall be UL approved.

Fuses and fuseholders shall be in accordance with the requirements of Section 1065.01 of the Standard Specifications.

All pole wires, including ground, shall run from the handhold to the luminaire. Interior cables shall be type 600 volt, XLP insulation, No. 10 AWG stranded copper conductors. Color coding of the pole wire shall be via solid insulation color. Neutral wires shall be white, ground wires shall be green and phase conductors shall be color coded red or black.

Festoon receptacle outlets shall be a duplex receptacle, 20 ampere, 120 volt with a weatherproof cover mounted 20 feet above finished grade, facing opposite side of oncoming traffic.

Luminaires shall be equipped with High Pressure Sodium Vapor lamps and shall have type II Distribution. The lamp wattage shall be determined by the photo metrics.

Fasteners and hardware shall be in accordance with the requirements of Section 1088.03 of the Standard Specifications.

Manufacturers. Luminaires shall be GE Lighting Systems, type Decashield XXX or approved equivalent.

Installation. The luminaire shall be installed in accordance with the requirements of Section 821 of the Standard Specifications.

~~**Basis of Payment.** This item shall be paid for at the contract unit price each for LUMINAIRE, SODIUM VAPOR, RECTILINEAR TYPE XXX WATT which price shall be payment in full for the luminaire, wiring, fusing, and wiring for receptacle, complete in place. The light pole will be paid for separately, as specified elsewhere in these special provisions.~~

~~**CONCRETE LIGHT POLE FOUNDATION**~~

~~**IDOT Standard Item**~~

~~Use IDOT's standard pay item for LIGHT POLE FOUNDATION, 24" DIAMETER with no modifications as described in Section 836. Pole Foundation of the IDOT Standard Specifications for Road and Bridge Construction.~~

DRAFT

**Special Provisions
for
T.I.F. Central Business District Street Light
Standards**

DRAFT

T.I.F. CENTRAL BUSINESS DISTRICT ORNAMENTAL LIGHTING STANDARD

Rev. 08/04

Light Poles (Ornamental Steel)

Luminaire (Ornamental T.I.F.)

Description. This work shall consist of furnishing and installing street lighting standards with luminaires in accordance with Section 800 of the Standard Specifications with the following alterations.

Materials. Materials shall meet the requirements of Sections 1065, 1066, and 1067 and the following.

Poles shall be made from a single, seamless 4" round piece of high-tensile carbon steel and welded over an 8 5/8" round high tensile carbon steel pole base. The assembly is welded to both the top and bottom of a steel base. The pole shall have an access door made of aluminum covering a maintenance opening of 4" x 10" giving access to ground lug. The decorative cover made of cast aluminum shall be mechanically fastened to the base with stainless steel screws. The finish shall be luminal polyester powder coat textured finish with durable UV-resistant exterior finish and outstanding salt-spray resistance according to ASTM testing procedures. The color shall be submitted to the Village for approval prior to manufacturing.

The luminaire shall consist of a one-piece cast-aluminum square tapered housing with four clear polycarbonate lenses and a cast aluminum decorative hood with finial. Luminaires shall be equipped with 100 watt, 240 volt, High Pressure Sodium Vapor lamps. The optic system shall be a round prismatic borosilicate thermo-resistant refractor type 3 (asymmetrical) distribution, with an internal deflector.

The ladder rests shall be made of steel tubing, 1 1/16" outer diameter mechanically held. The bottom set of the ladder rest shall have a removable band.

Festoon receptacle outlets shall be a duplex receptacle, 15 ampere, 120 volt with a weatherproof cover mounted near the top of the pole.

Manufacturers. The light poles shall be Lumec Inc. model C1-RS61A-12'-DR-120-RSV-5069-BR. The luminaires shall be Lumec Inc. model 100-HPS-L26-C-RR30-240-RSV-5069-BR or Stresscrete K601D-F2.

Basis of Payment. This work will be paid for at the contract unit price each for ORNAMENTAL LIGHT POLE, STEEL, 12 FT., MOUNTING HEIGHT and ORANMENTAL LUMINAIRE, 100 WATT HPS which price shall include all labor, equipment and materials to complete the work as specified herein.

CONCRETE LIGHT POLE FOUNDATION

IDOT Standard Item

Use IDOT's standard pay item for LIGHT POLE FOUNDATION, 24" DIAMETER with no modifications as described in Section 836. Pole Foundation of the IDOT Standard Specifications for Road and Bridge Construction.

DRAFT

|

Exhibit 1

Residential Street Light Standard Details

Light Poles (Concrete Flared Base)

Light Poles (Concrete Straight Base)

Luminaire (Ornamental)

DRAFT

**Residential Street Lights
Concrete Flared Base Poles**

Ameron Centrecon VEM-4.6

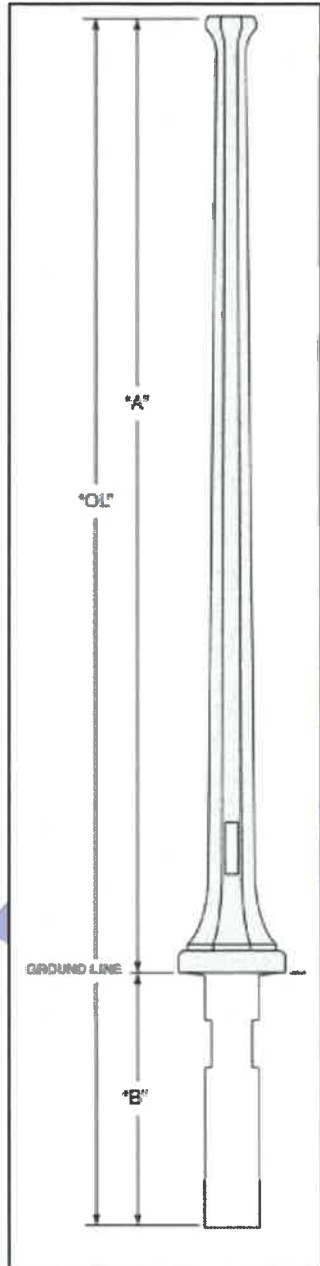

Stresscrete KS15

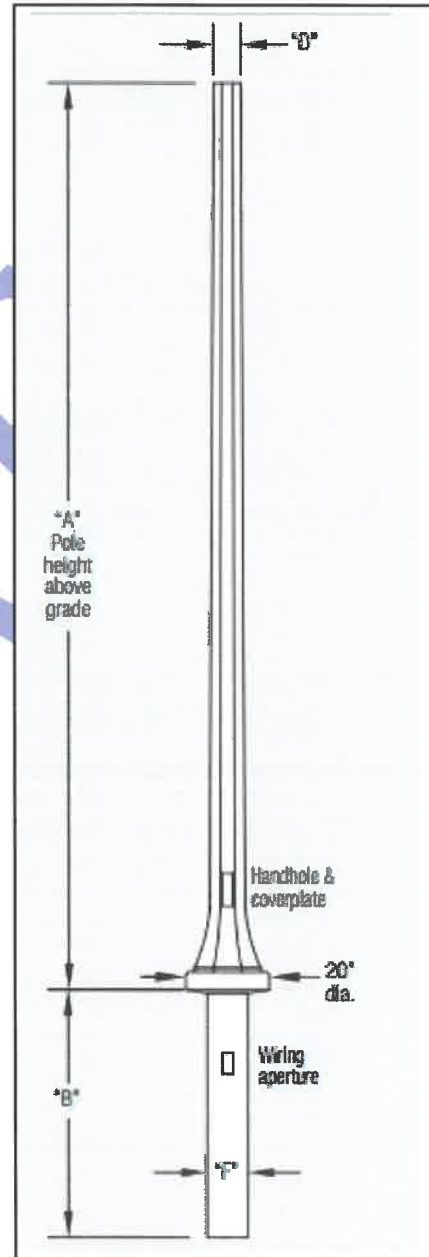

**Residential Roadway Luminaries
Ornamental LED**

Sternberg MS805BLED

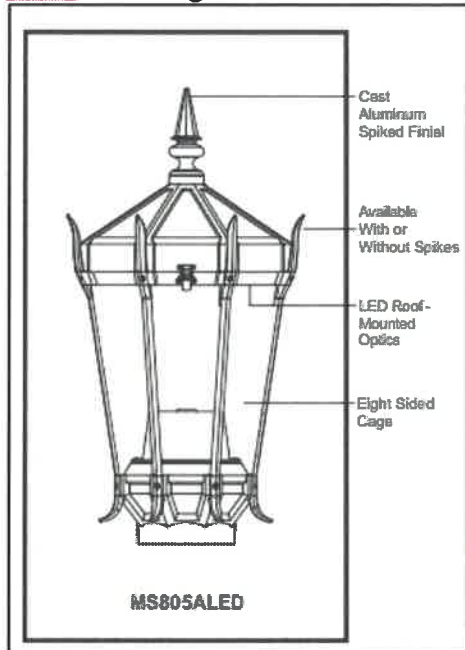

Lumec L70-001

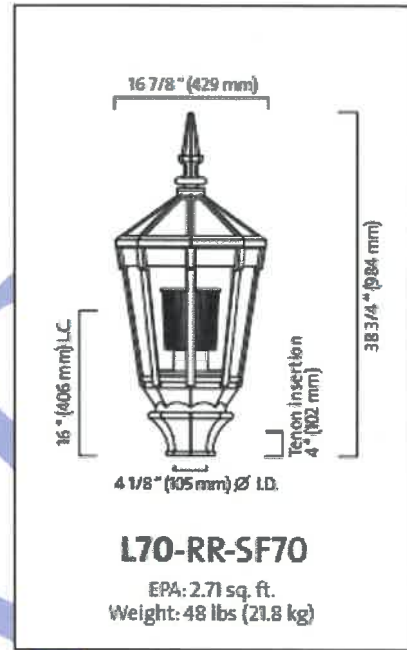

Exhibit 2

Arterial Street Light Standard Details

Decorative Street Light Standard

Light Poles (Decorative) with Luminaire (Decorative – Down Light) and
Luminaire (Ornamental – Bracket Mounted)

Light Pole (Spun Aluminum)

Light Pole (Concrete)

Luminaire (Roadway)

~~Light Pole (Square Steel)~~

~~Luminaire (Rectangular)~~

Concrete Light Pole Foundation

DRAFT

**Arterial Roadway Lights
Decorative Light Poles**

Oxford 9300

9201-SS Oxford base Cover

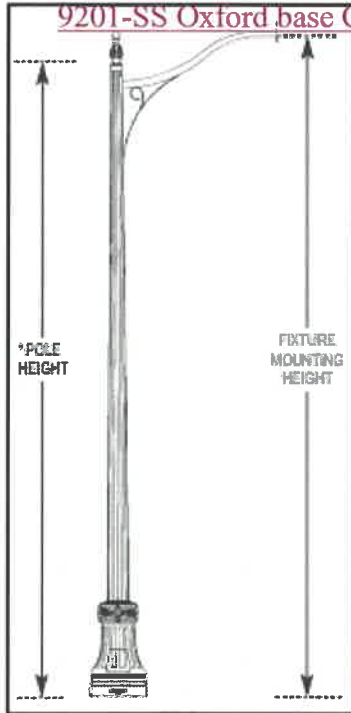

Sternberg DAG Arm



9201-SS Oxford base Cover_

Sternberg-DAG Arm

Sternberg MS805BLED

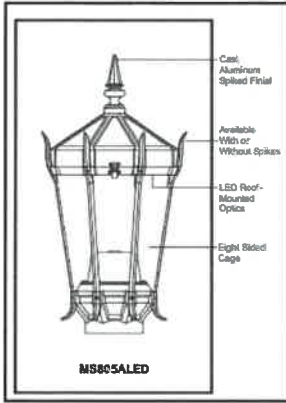

Sternberg 1914A Libertyville



Hadco Teardrop TF9

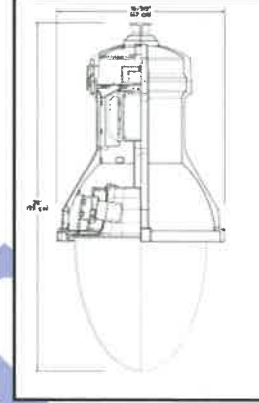

Arterial Light Pole

Hapco Series 20

Hapco Series 30

DRAFT

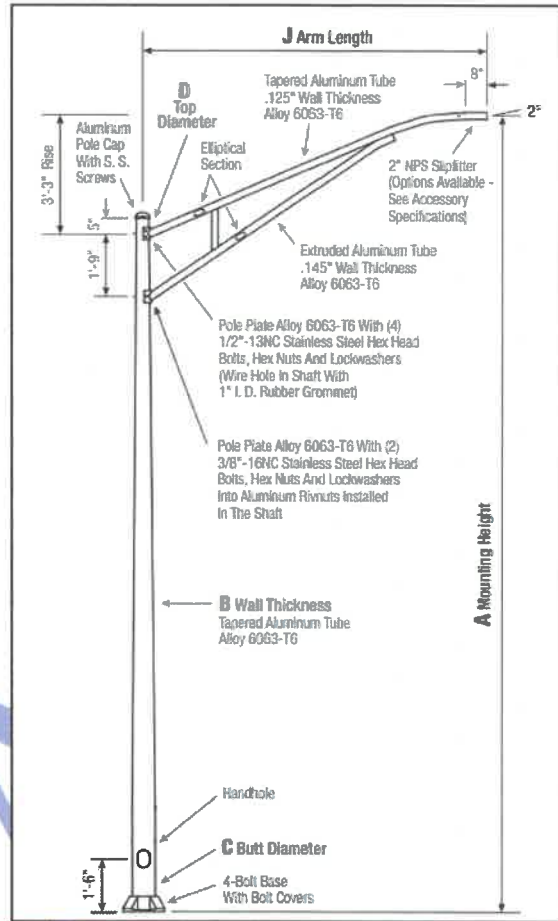
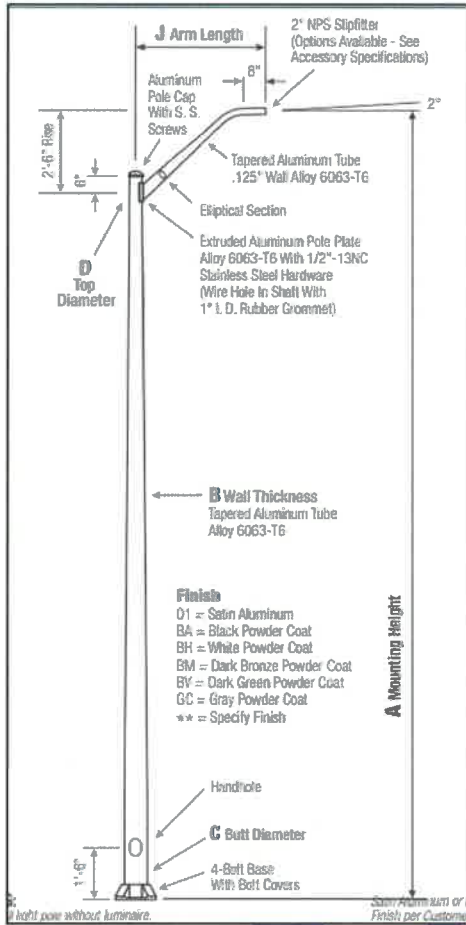

DRAFT

**Arterial Roadway Luminaire
Cobra Head LED**

American Electric Autobahn ATB2 60B

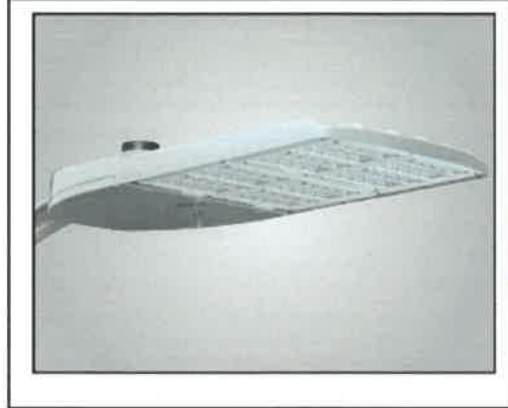

Cooper Lighting Navion NVN-AA-04-E-U-SL2

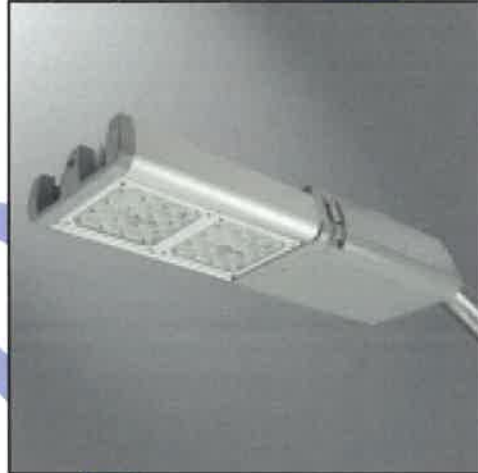

General Electric Evolve ERs3-MX-BX-5-40-4-Grey



|

Exhibit 3

| **T.I.F. Central Business District Street Light Standard Details**

| **T.I.F. Central Business District Ornamental Lighting Standard**
| Light Poles (Ornamental Steel)
| Luminaire (Ornamental **T.I.F.**)

Concrete Light Pole Foundation

DRAFT

**Downtown-TIF Central Business District Roadway
Steel Flared Base Poles**

Lumec
C1-RS61A-12'-DR-120-RSV-5069-BR

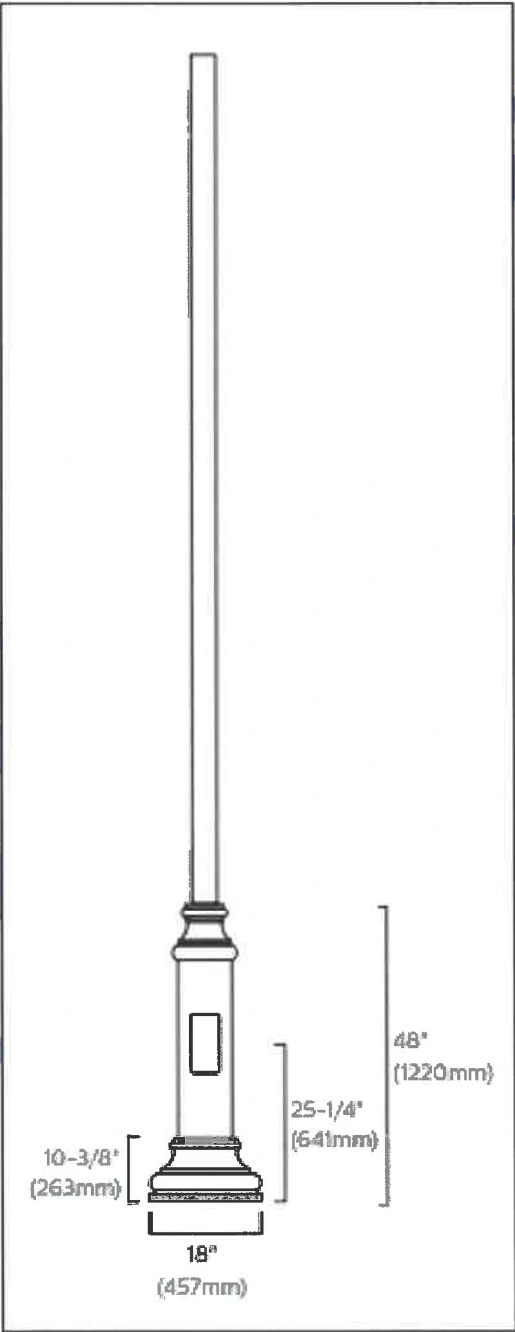

~~Downtown~~ Central Business District Roadway Luminaries
Ornamental LED

Lumec

100-HPS-L26-C-RR30-240-RSV-5069-BR

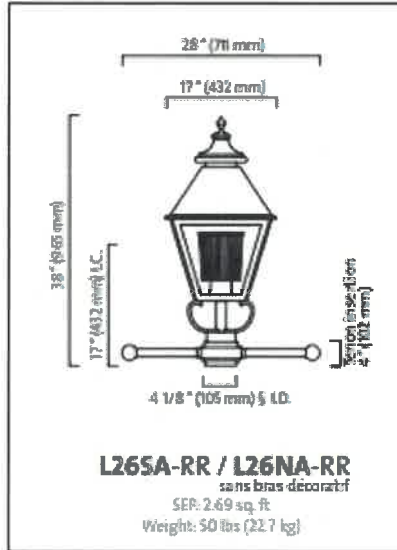

Stresscrete K601D-F2

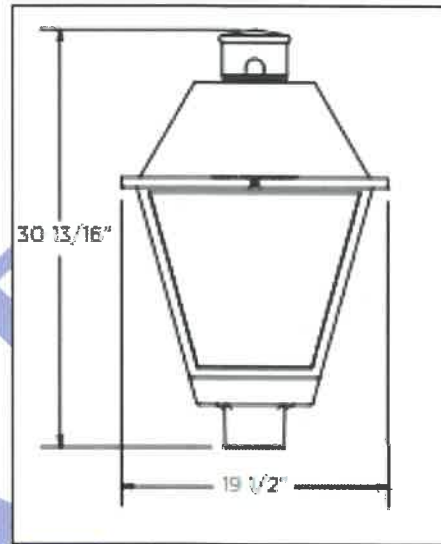

DRAWING